



NINJAGO

DRAGONS RISING

71791



WARNING: CHOKING HAZARD.
Toy contains small parts and a small ball.
Not for children under 3 years.



Get excited about our new packaging!

We're switching from plastic to paper-based packaging. That's why you might find a mix of paper and plastic in our boxes!

Nos nouveaux emballages vous emballeront !

Nous passons des emballages en plastique aux emballages à base de papier. C'est pourquoi vous pourriez trouver un mélange de papier et de plastique dans nos boîtes !

¡Te presentamos nuestros nuevos empaques!

Estamos sustituyendo las bolsas de plástico por bolsas con base de papel. ¡Por eso, puedes encontrar una mezcla de papel y de plástico en nuestras cajas!

[LEGO.com/sustainable-packaging](https://www.lego.com/sustainable-packaging)



BUILDER



Apple and the Apple logo are trademarks of Apple Inc., registered in the U.S. and other countries and regions. App Store is a service mark of Apple Inc. Google Play and the Google Play logo are trademarks of Google LLC. Tencent and the Tencent logo are trademarks of Tencent Inc.

Q [LEGO.com/devicecheck](https://www.lego.com/devicecheck)

EN Ask parents' permission before going online | **DE** Eltern um Erlaubnis bitten, bevor du online gehst | **FR** Demande l'autorisation d'un parent avant d'aller en ligne | **IT** Chiedi il permesso ai tuoi genitori prima di andare online | **ES** Pídeles permiso a tus papás antes de conectarte a Internet | **PT** Pede autorização aos pais antes de acederes online | **ZH** 上网前应先征得父母的同意 | **PL** Poproś rodziców o zgodę, zanim wejdziesz do Internetu | **CS** Než půjdeš na internet, požádej rodiče o svolení | **SK** Skôr než pôjdeš na internet, vypýtaj si povolenie od rodičov | **HU** Kérj szülői engedélyt, mielőtt online csatlakoznál! | **RO** Cere permisiunea părinților înainte de a te conecta online | **BG** Поискайте разрешение от родител, преди да влезете онлайн | **LV** Pirms došanās tiešsaistē palūdz atļauju vecākiem | **ET** Enne Interneti kasutamist küsi vanematelt luba | **LT** Prieš prisijungdami prie interneto, atsilkauskite tėvų

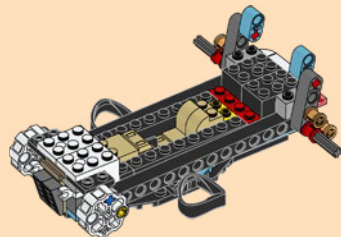

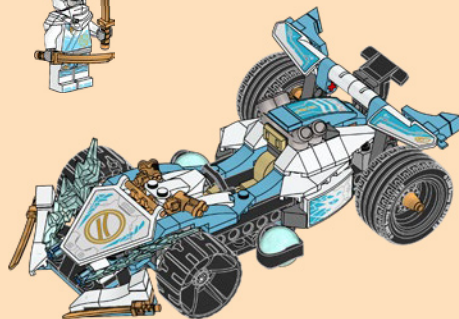
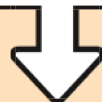
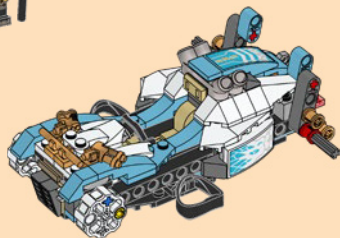



AVERTISSEMENT :

RISQUE D'ÉTOUFFEMENT.

Le jouet contient des petites pièces ainsi qu'une petite boule. Il ne convient pas aux enfants de moins de 3 ans.



ADVERTENCIA:

PELIGRO DE ASFIXIA.

Juguete que contiene partes pequeñas y una pelota pequeña. No recomendado para niños menores de 3 años.



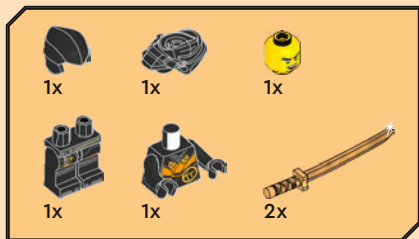

1

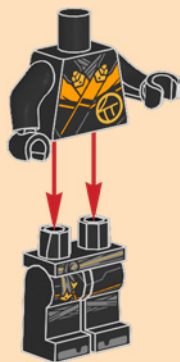

2

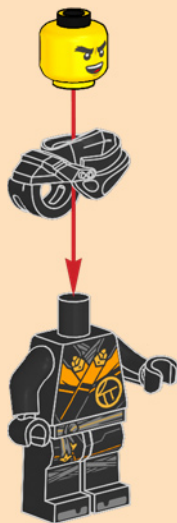

3

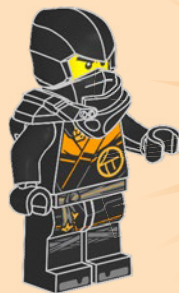

4



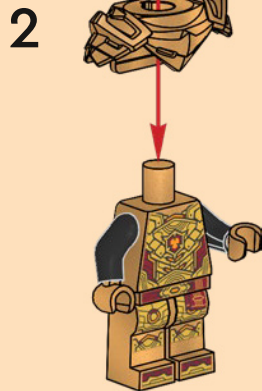
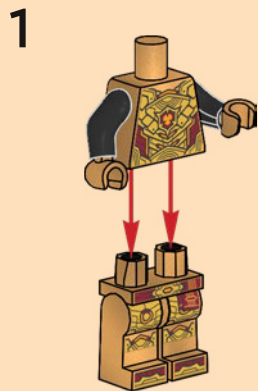
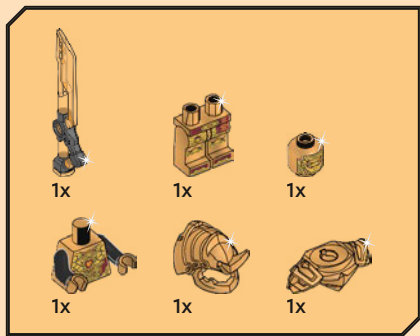

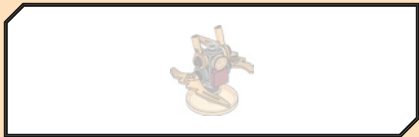

1



2

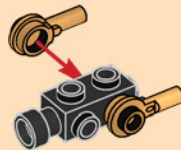



3

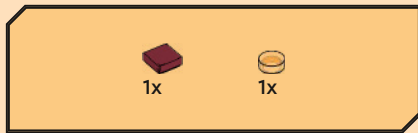
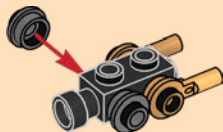

4



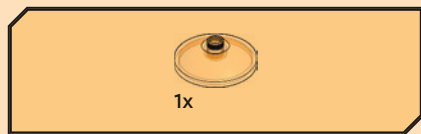

5

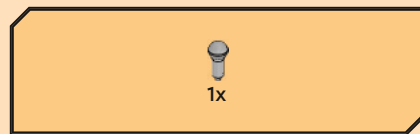

6

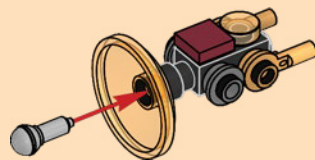



7

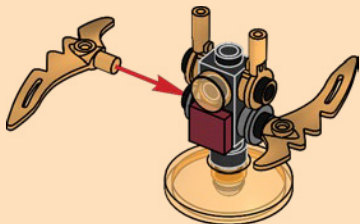

8

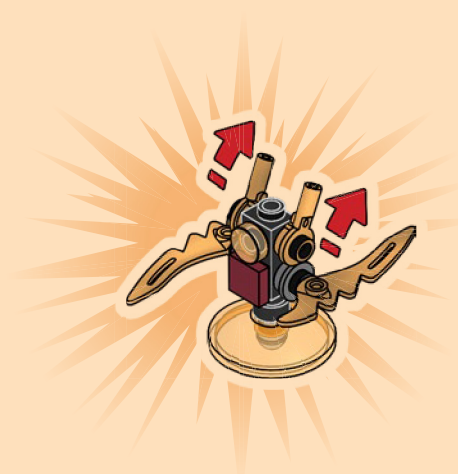



2x



1x

1



1x

2

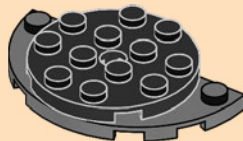



3

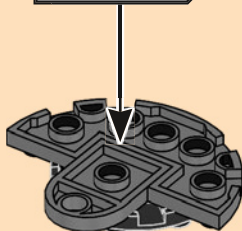

4



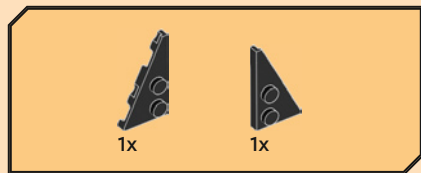

5

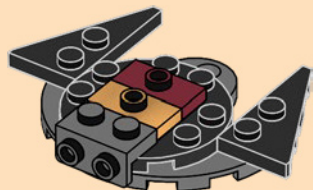

6

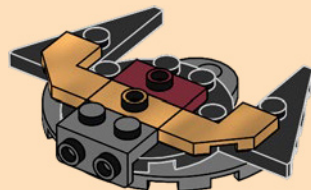

7

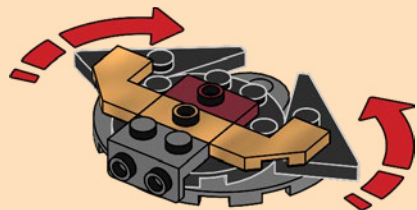

8

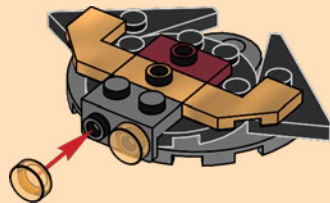

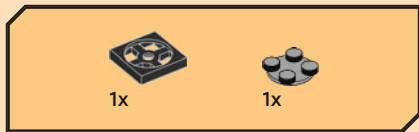

9

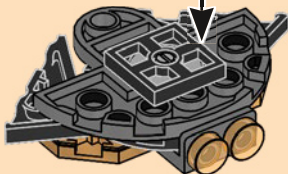
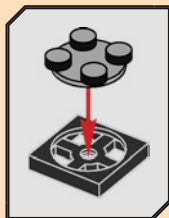

10

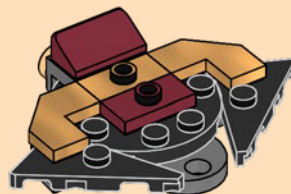



11

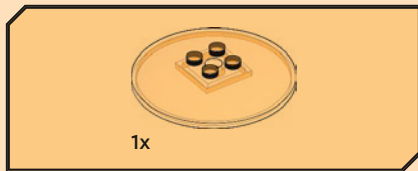
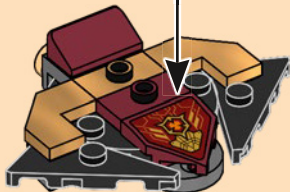

12

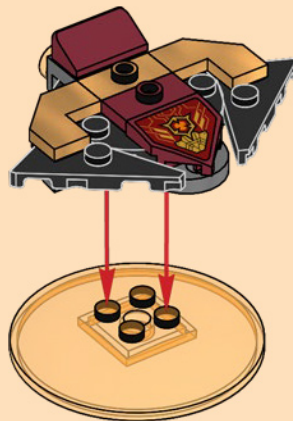

2x



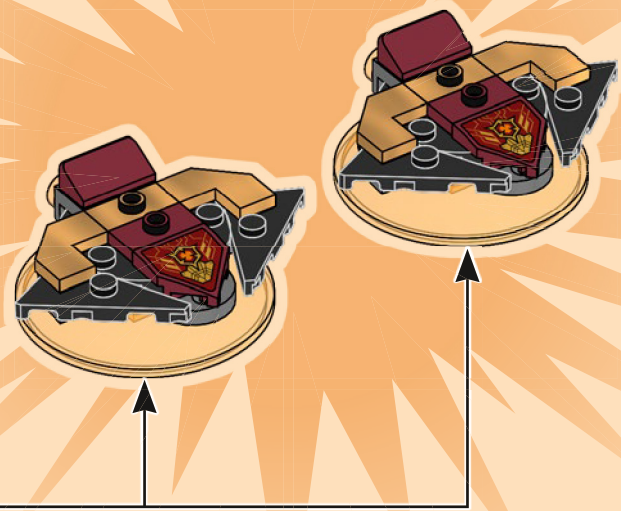



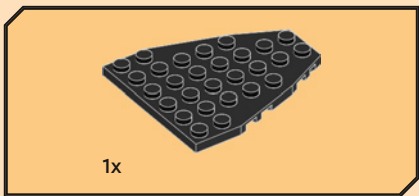
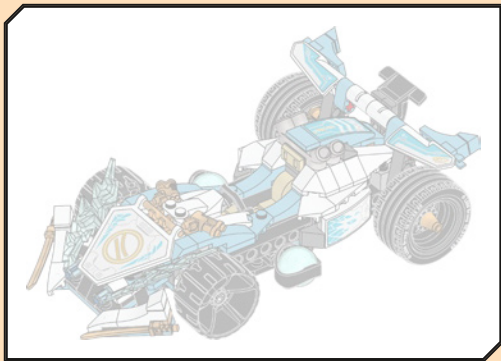

1x

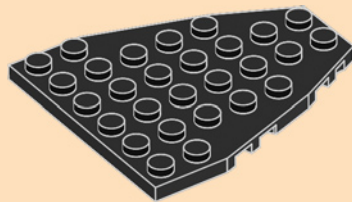

1

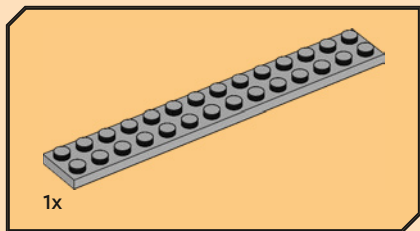

2

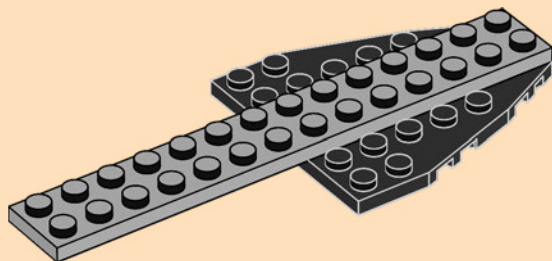

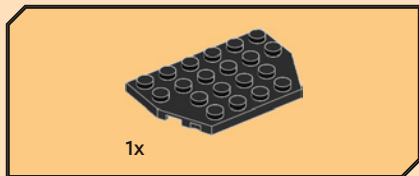

3

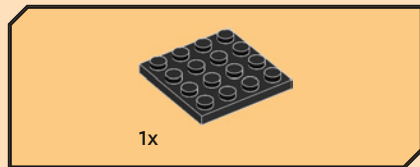
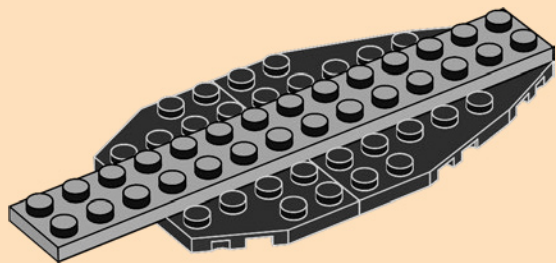

4

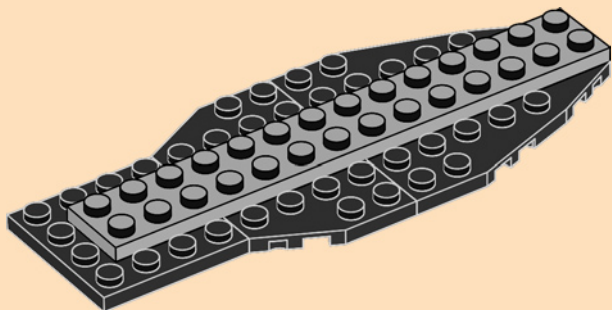



1x

5

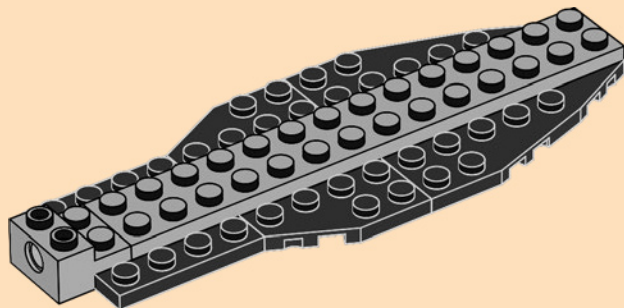

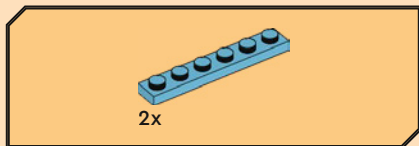

6

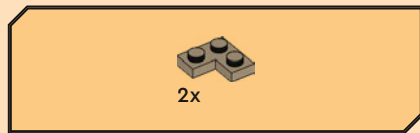
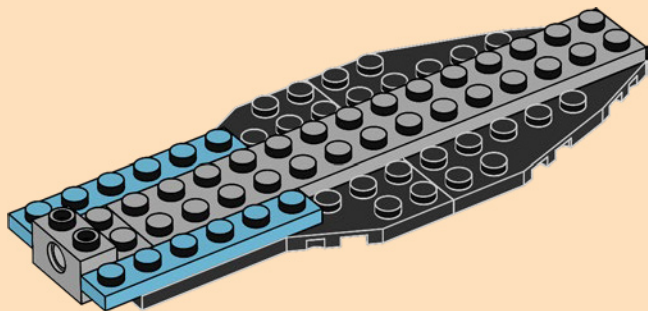

7

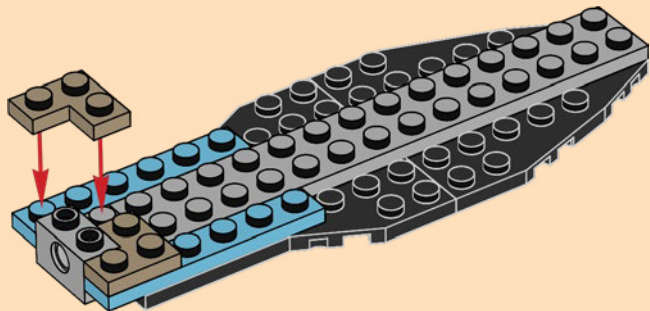

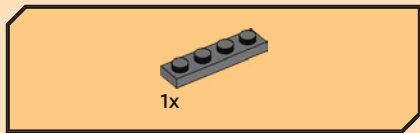

8

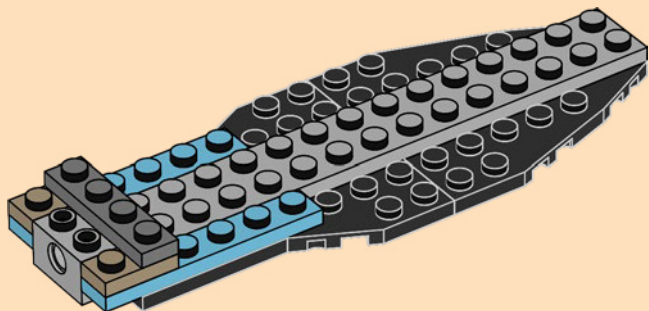

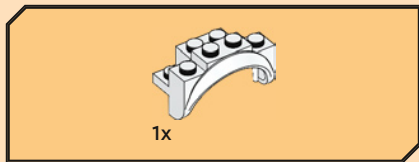

9

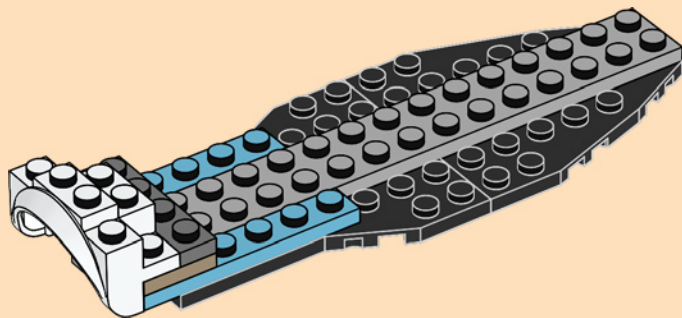



2x

10

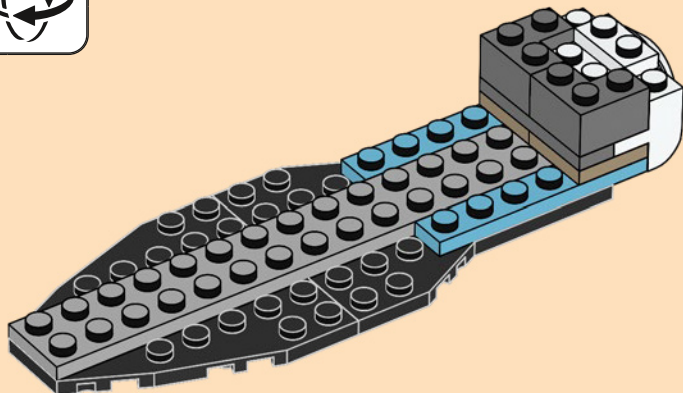



3x

11

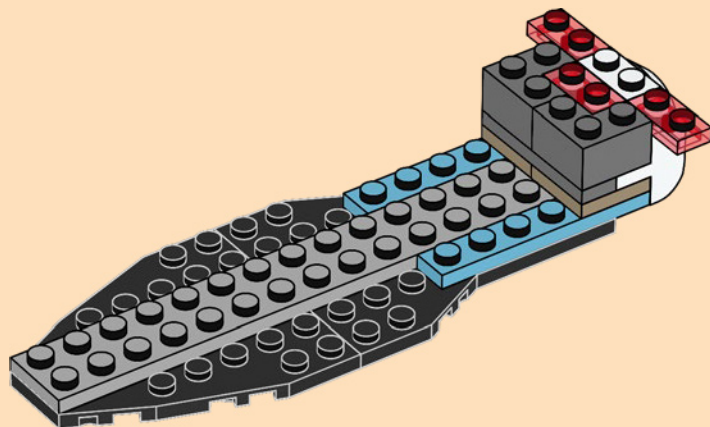



2x

12

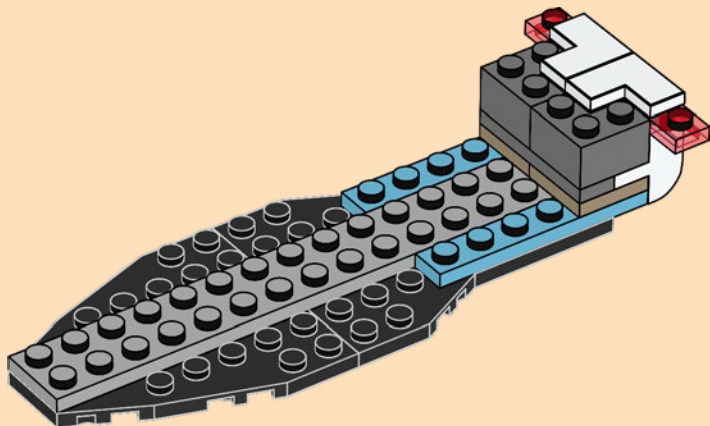



13

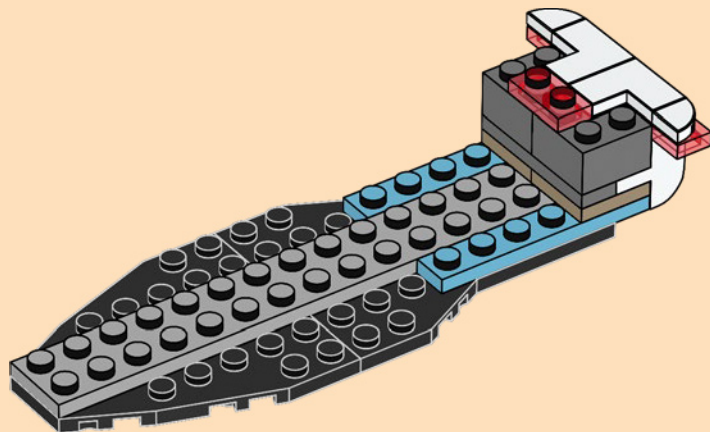



2x

14

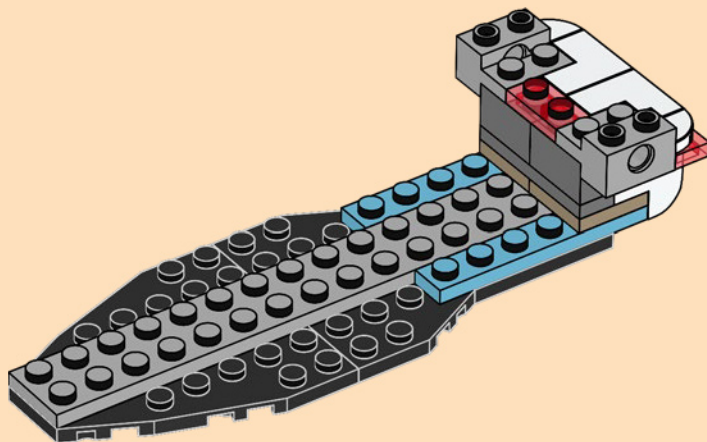

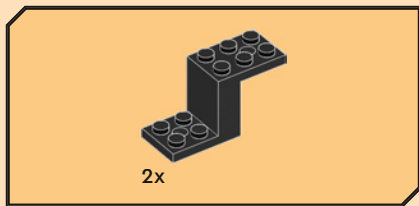

15

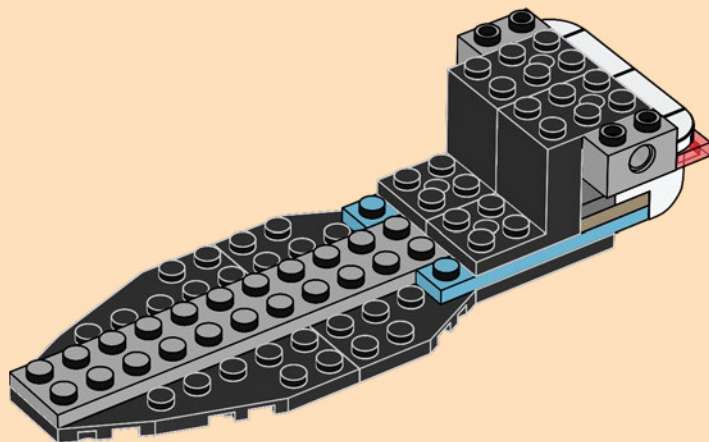

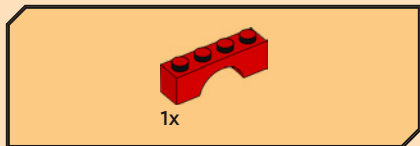

16

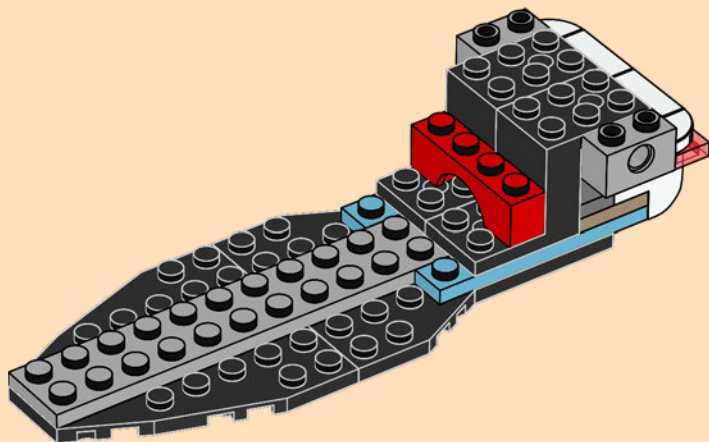

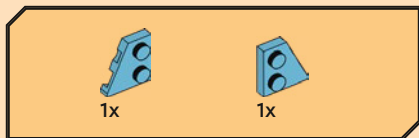

17

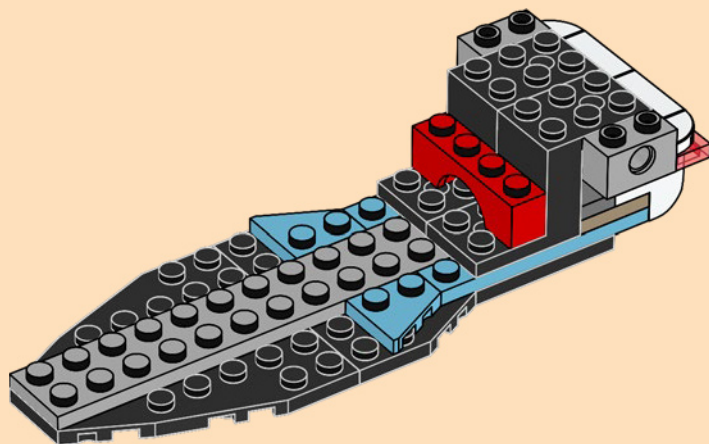

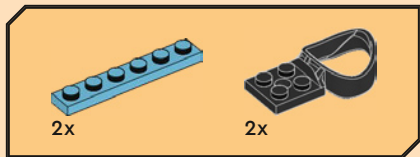

18

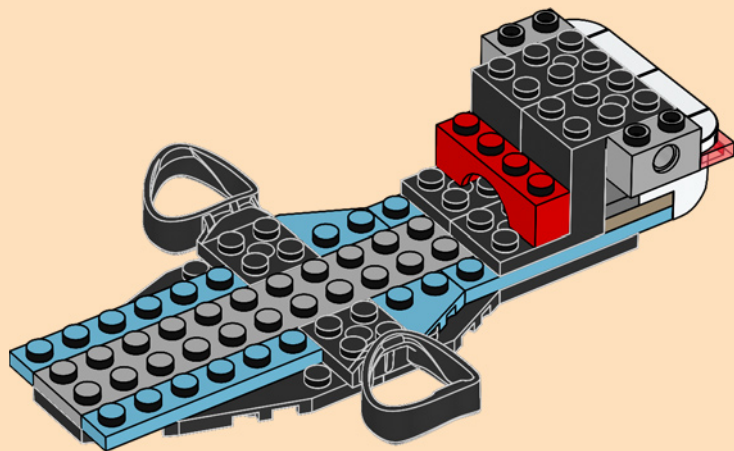

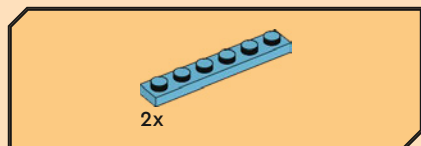

19

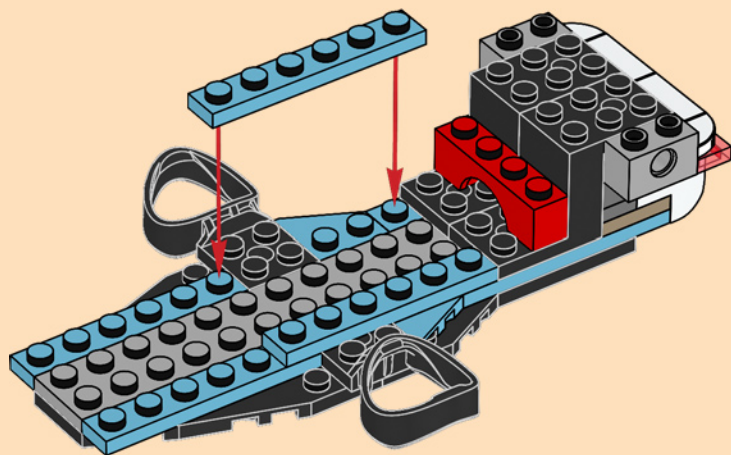

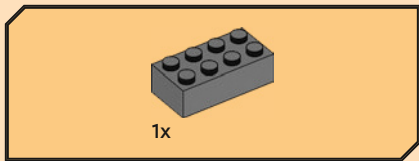

20

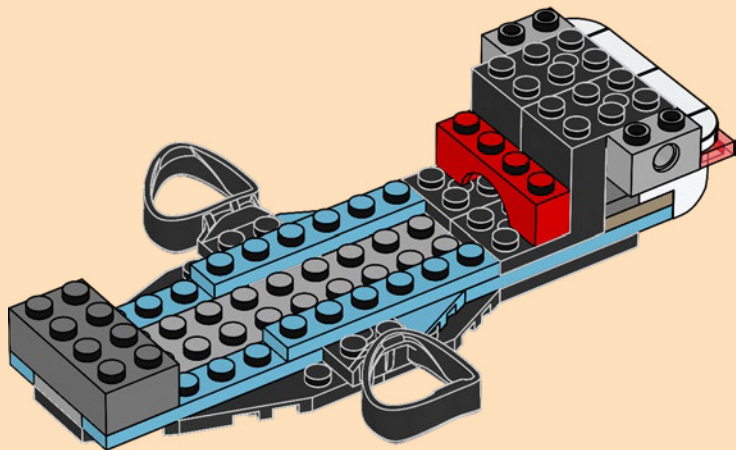



21

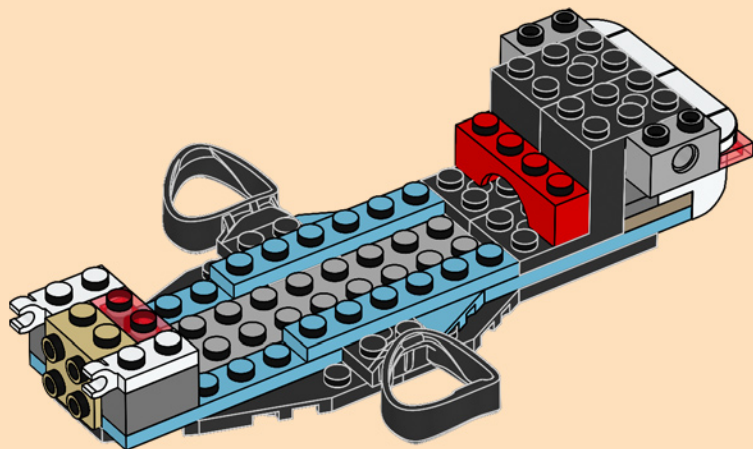



1x

22

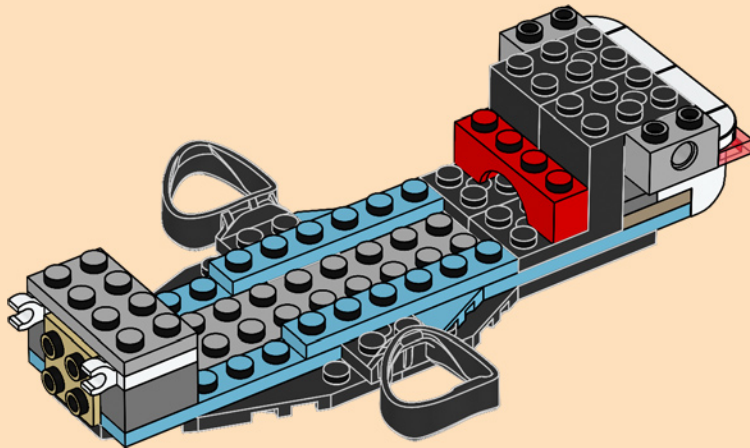

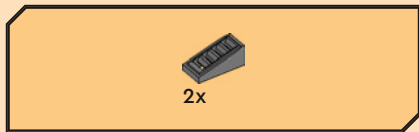

23

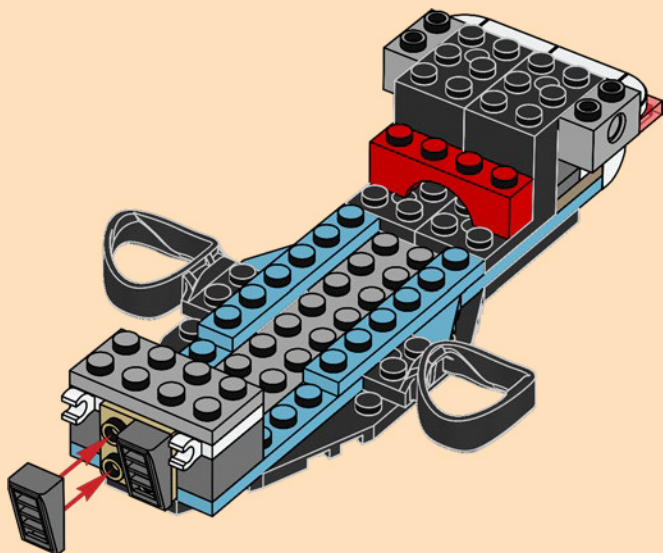

24

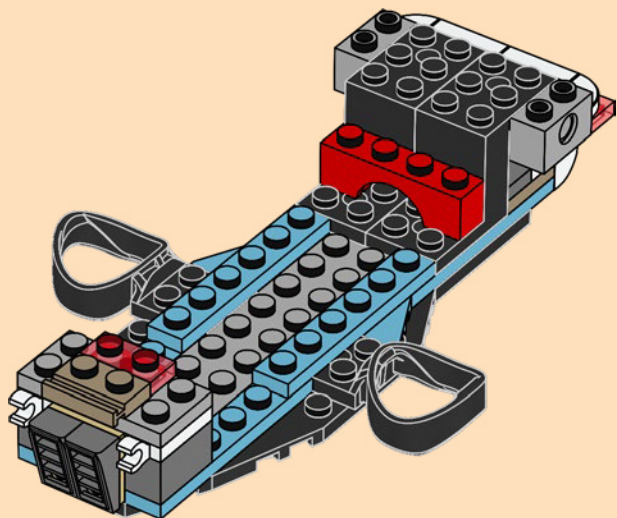



2x

25

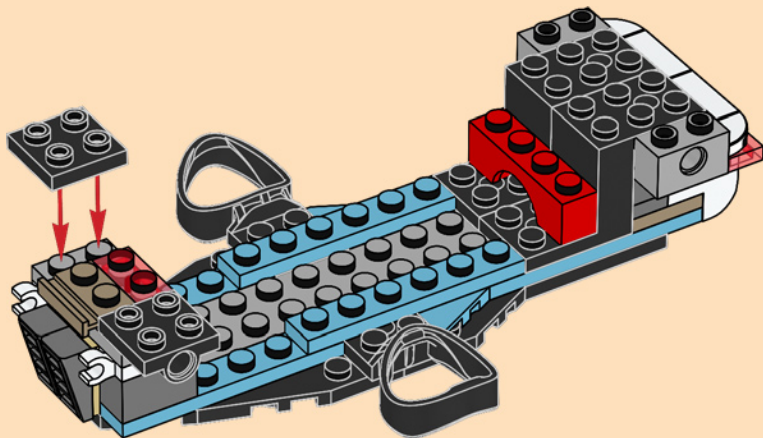

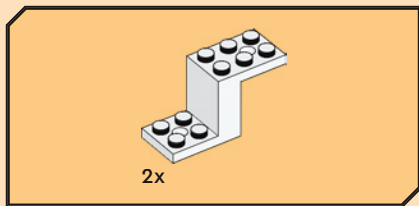

26

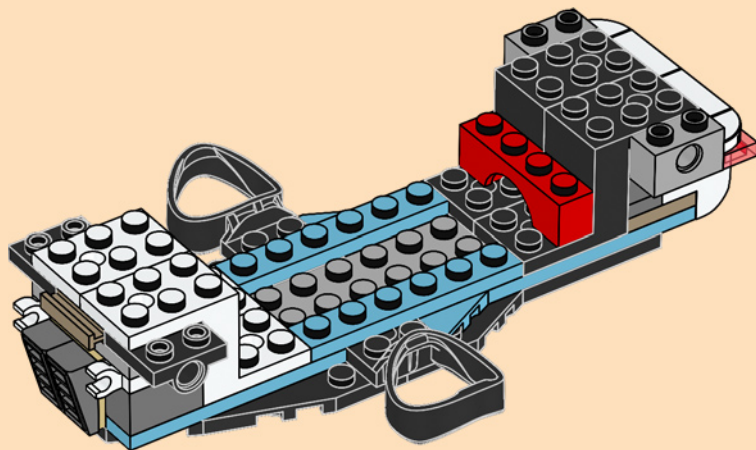

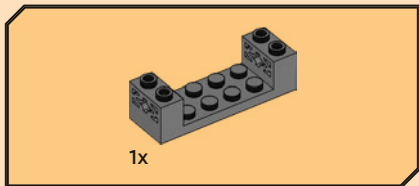
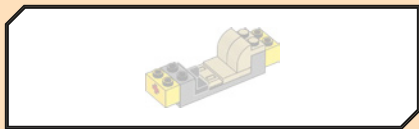

27

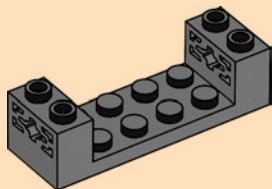

28

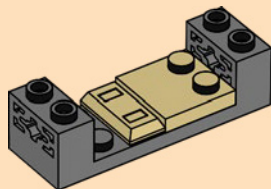



1x

29

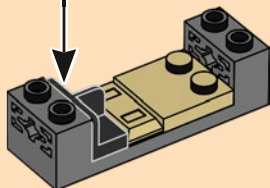

2x

30

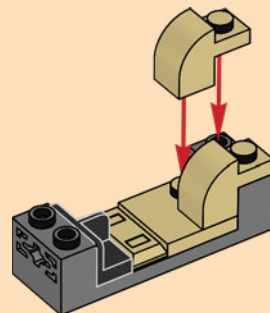

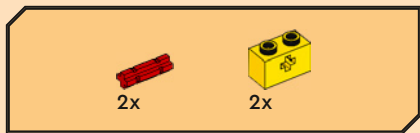

31

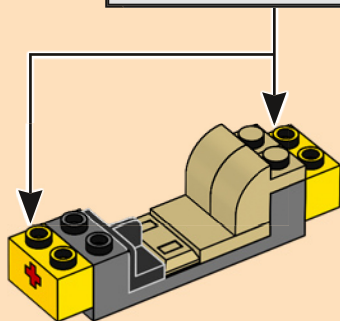
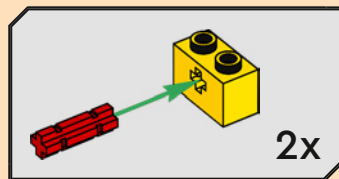

32

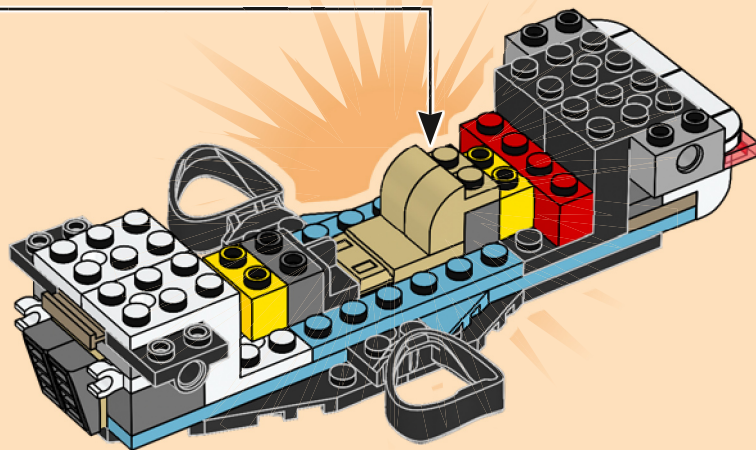

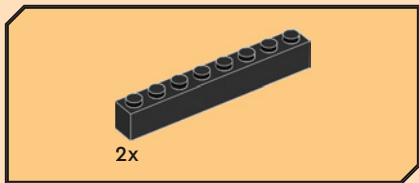

33

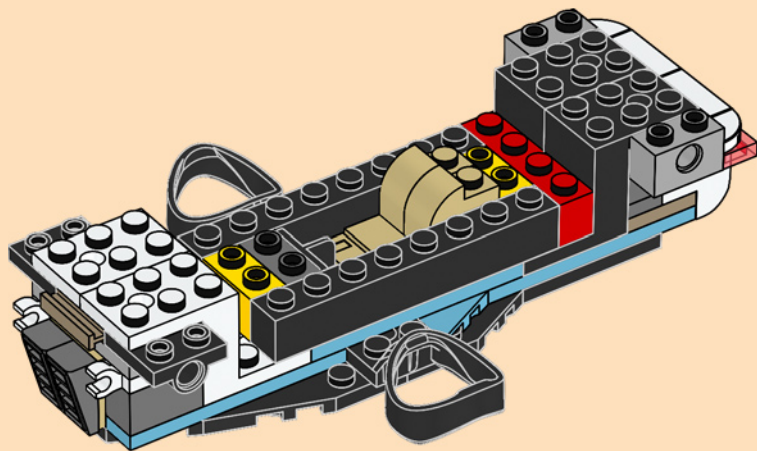

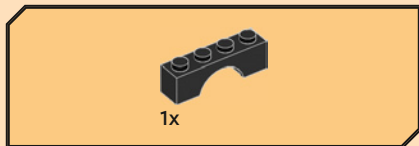

34

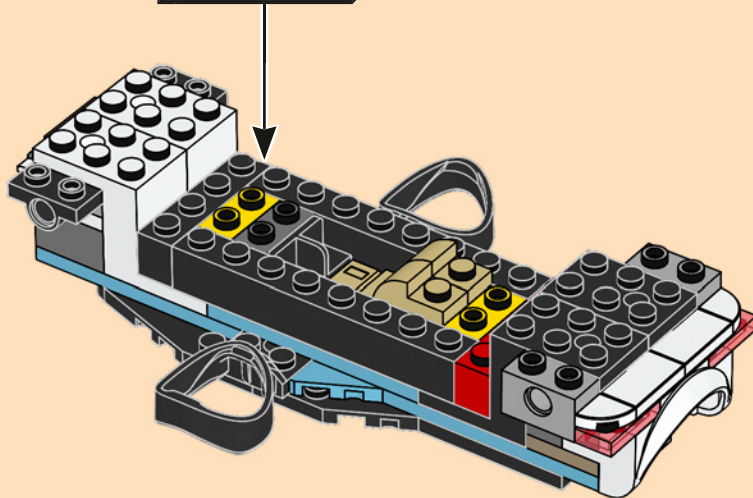
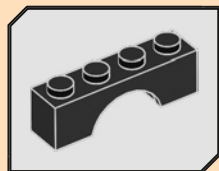

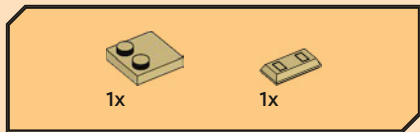

35

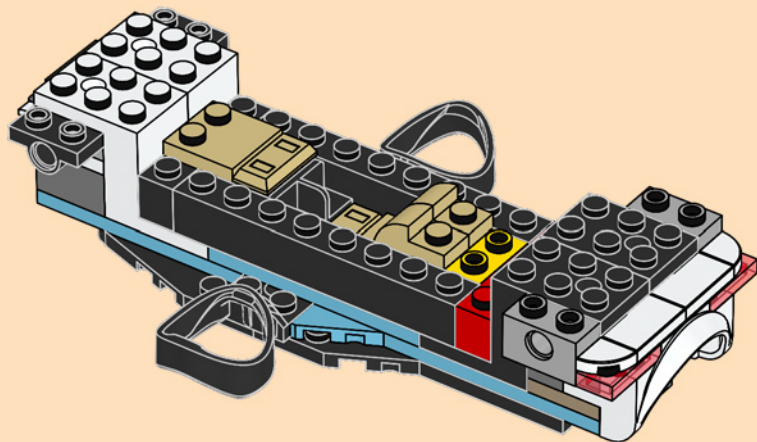

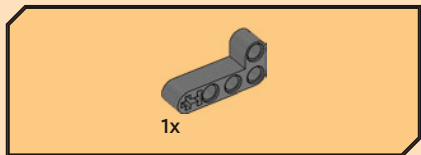
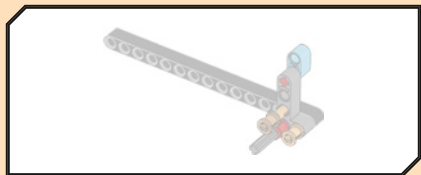

36

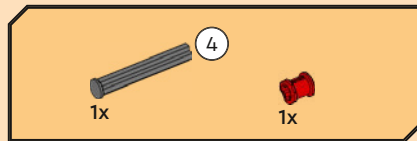
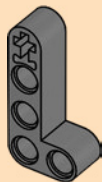

37

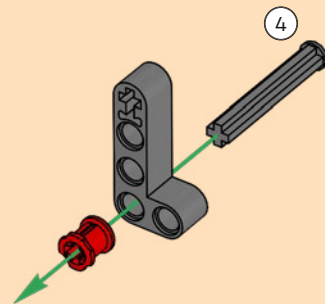



38

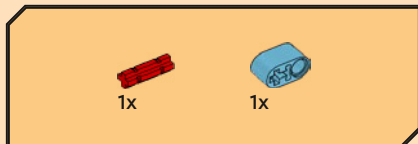
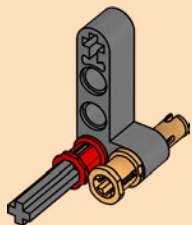

39

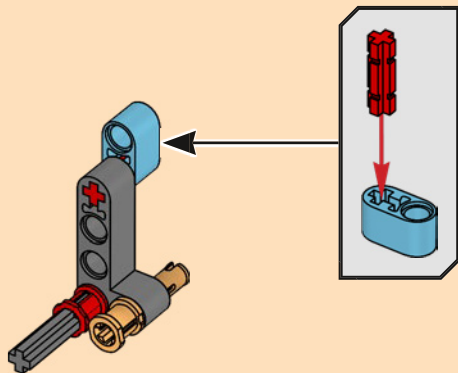

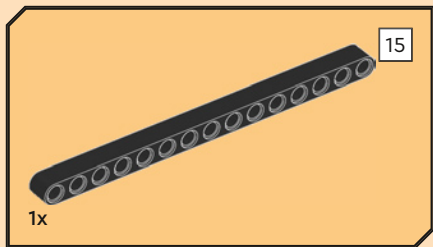

40

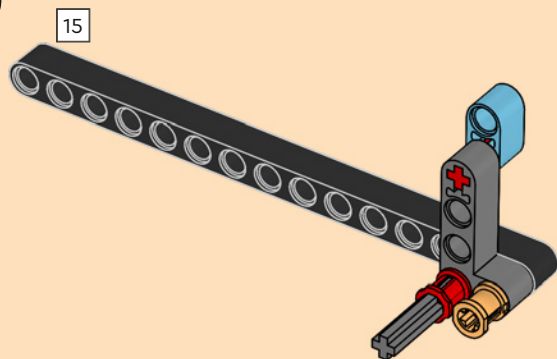

41

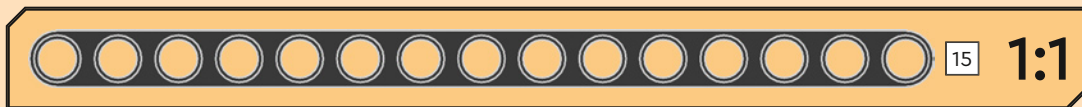
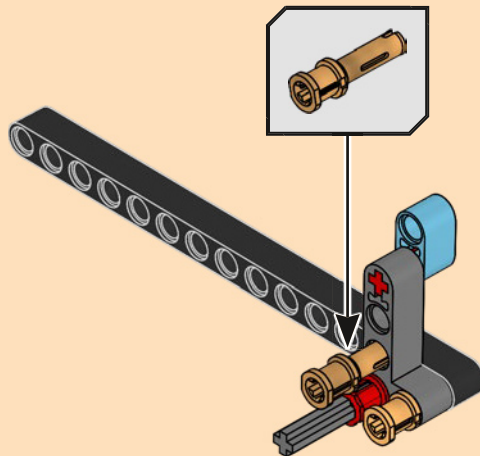

42

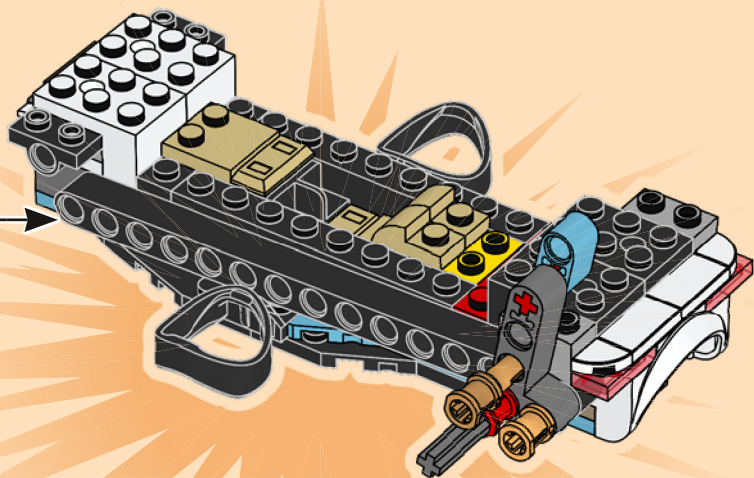

43

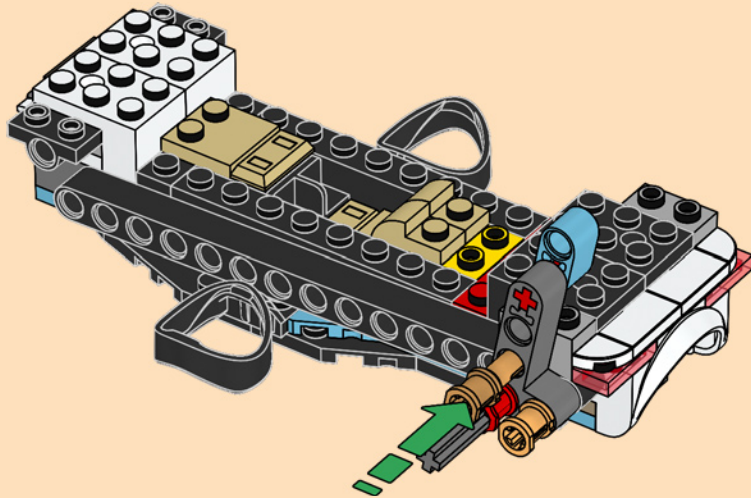

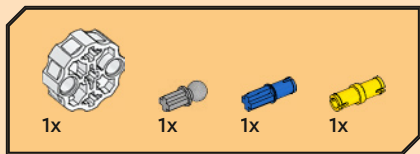

44

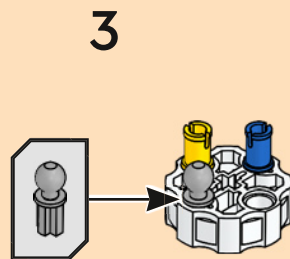
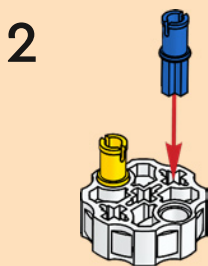
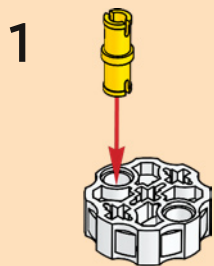

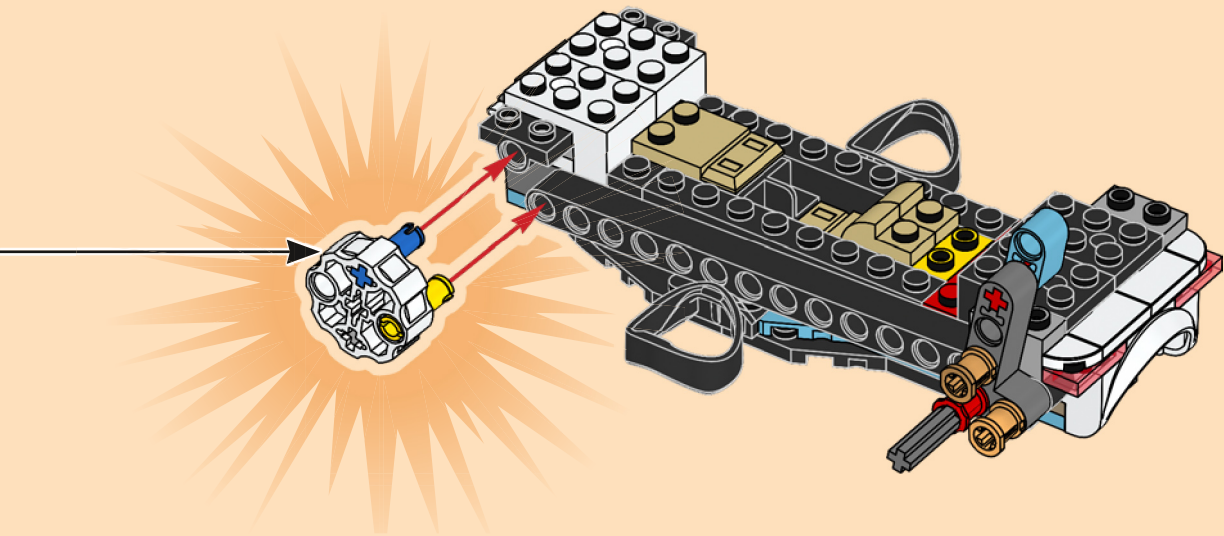

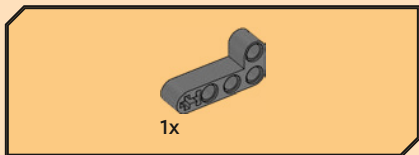
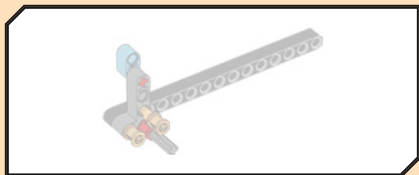

45

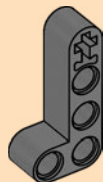

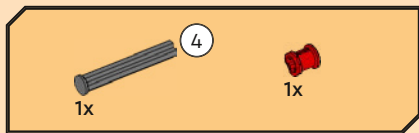

46

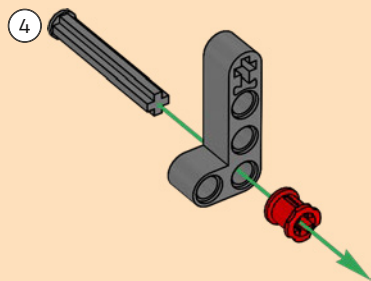

47

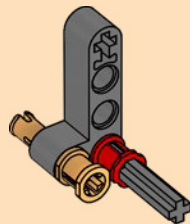

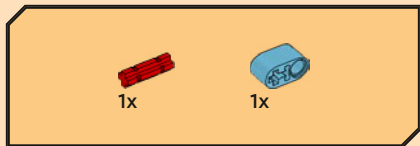

48

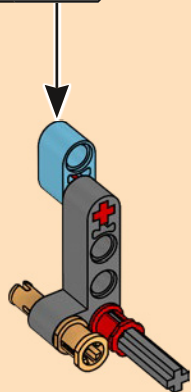
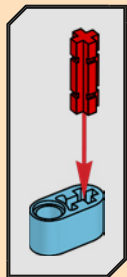

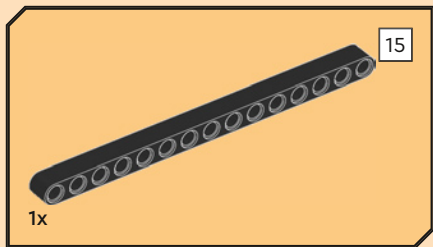

49

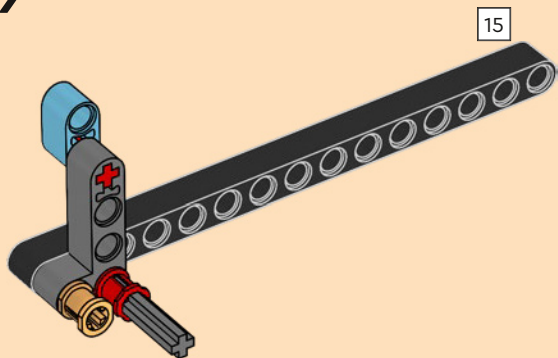

50

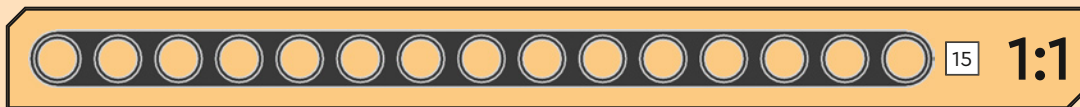
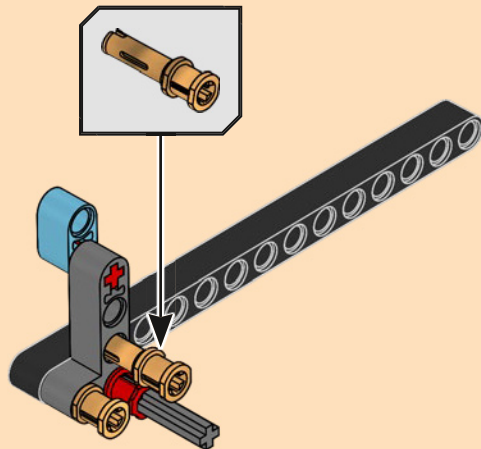

51

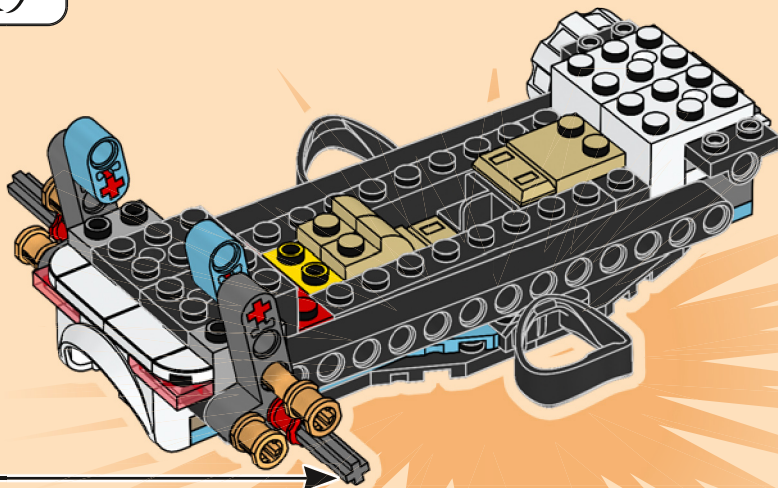

52

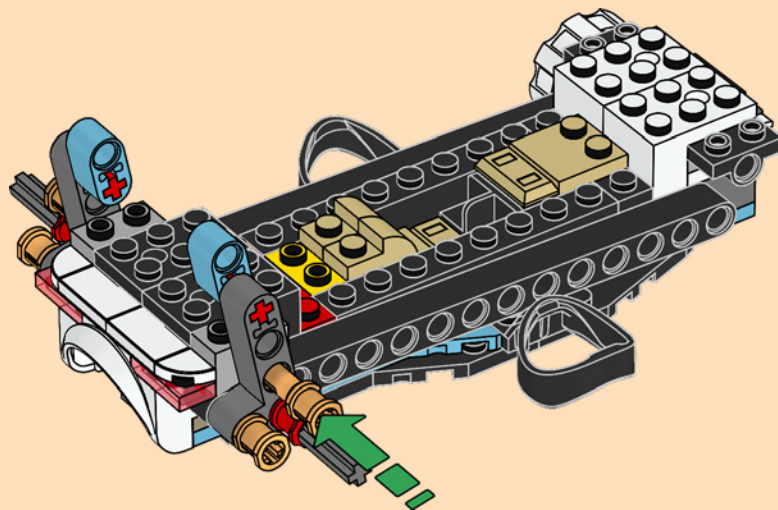

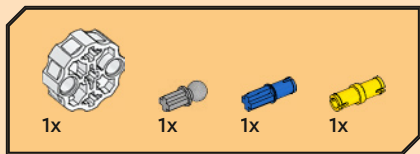

53

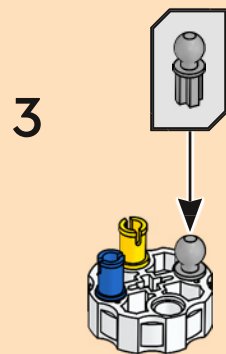
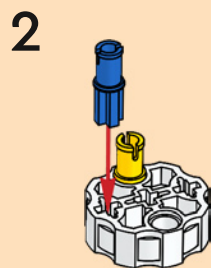
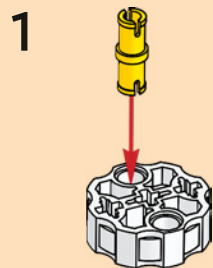

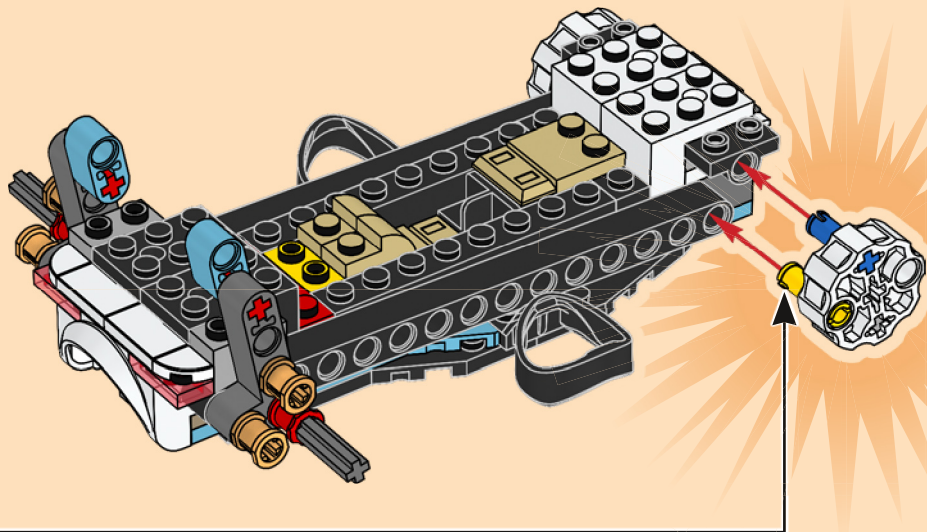



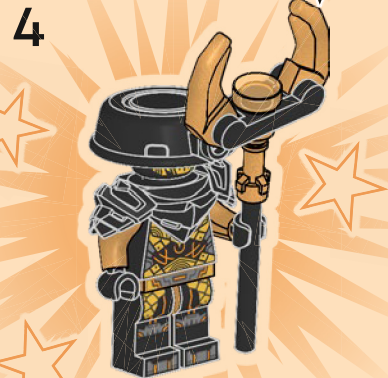
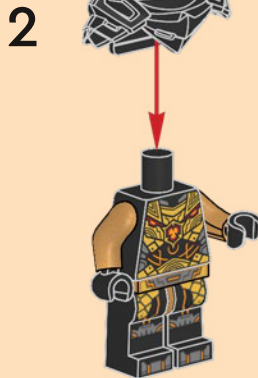
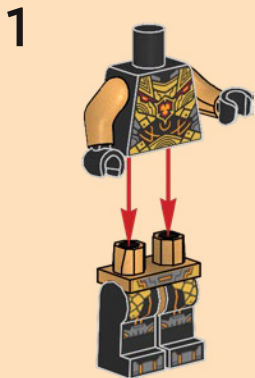
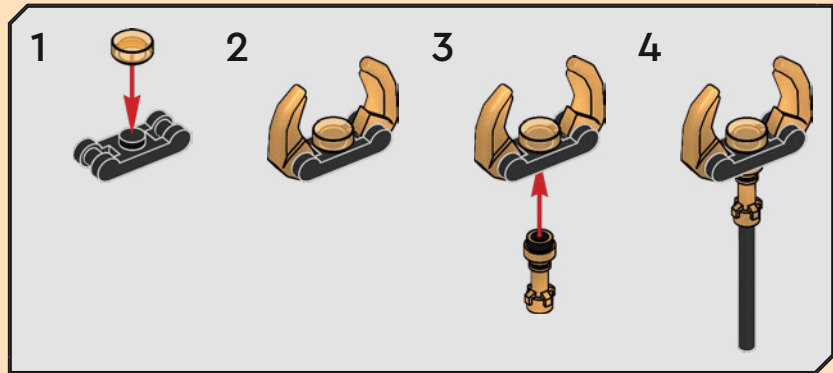
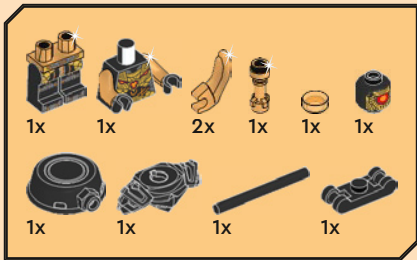

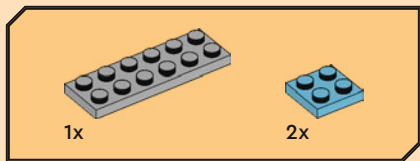

54

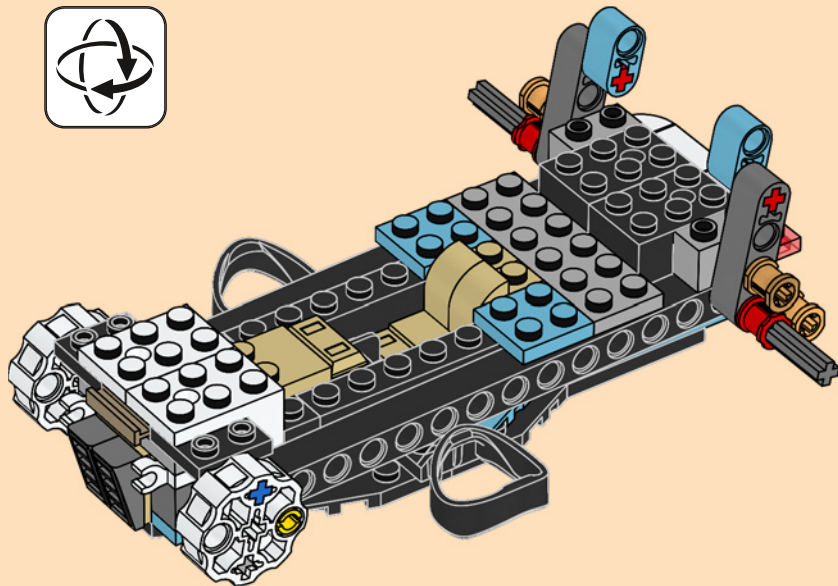



1x



2x

55

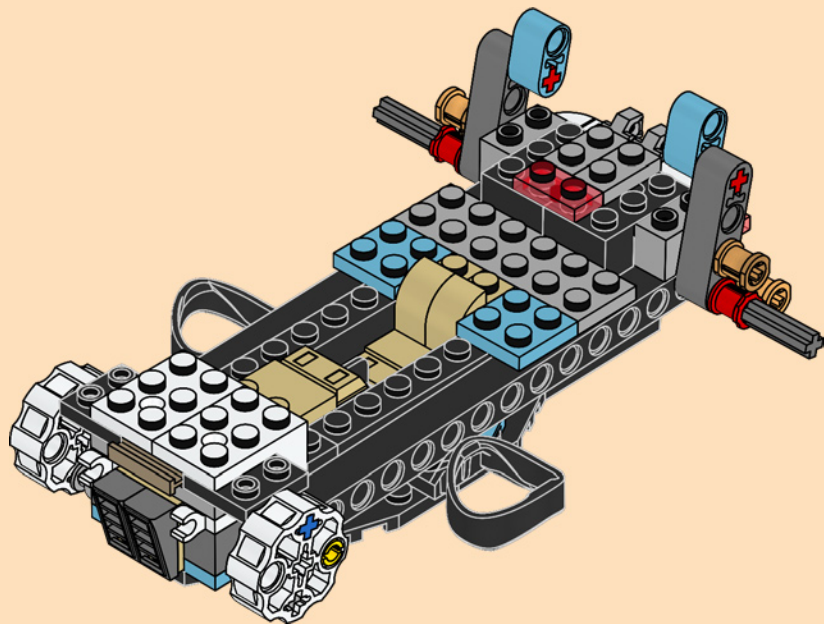

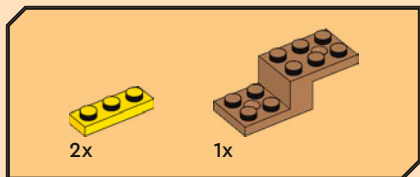

56

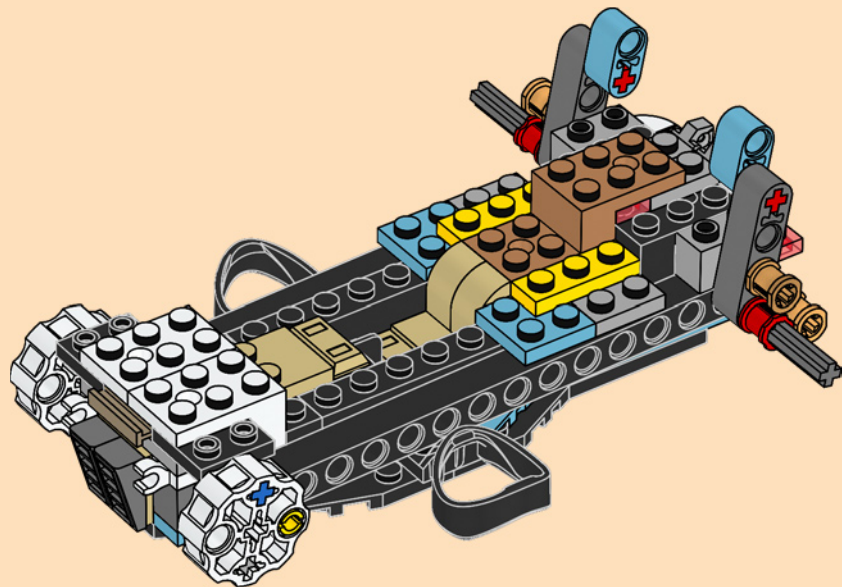



4x

57

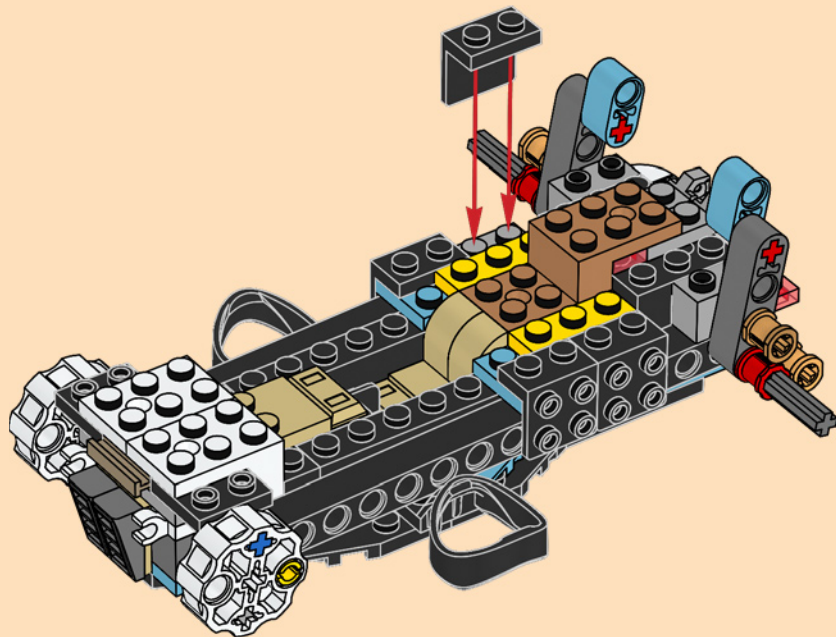

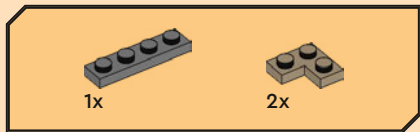

58

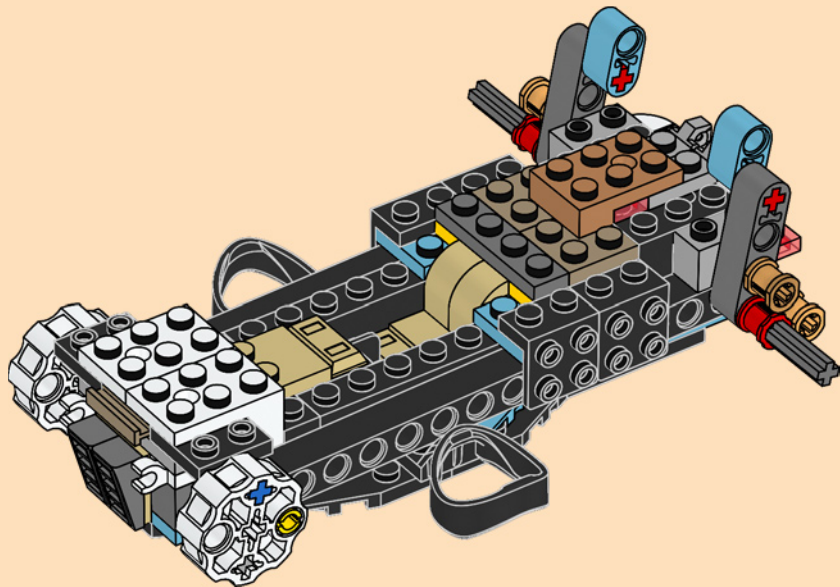



2x

59

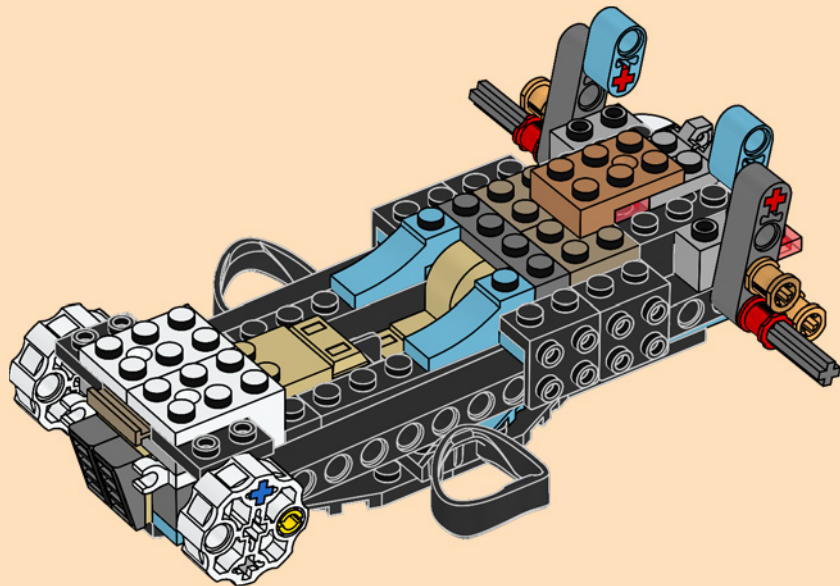

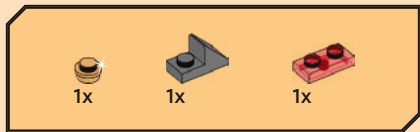

60

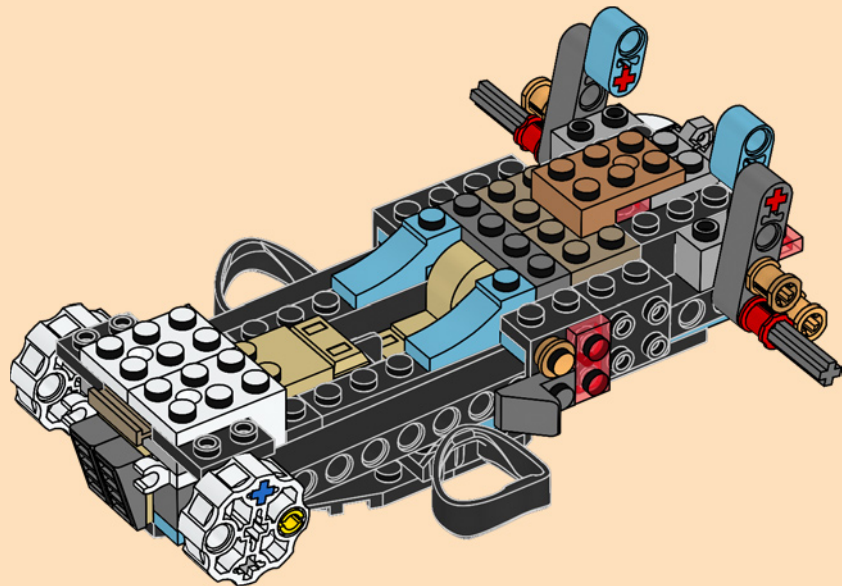



1x

61

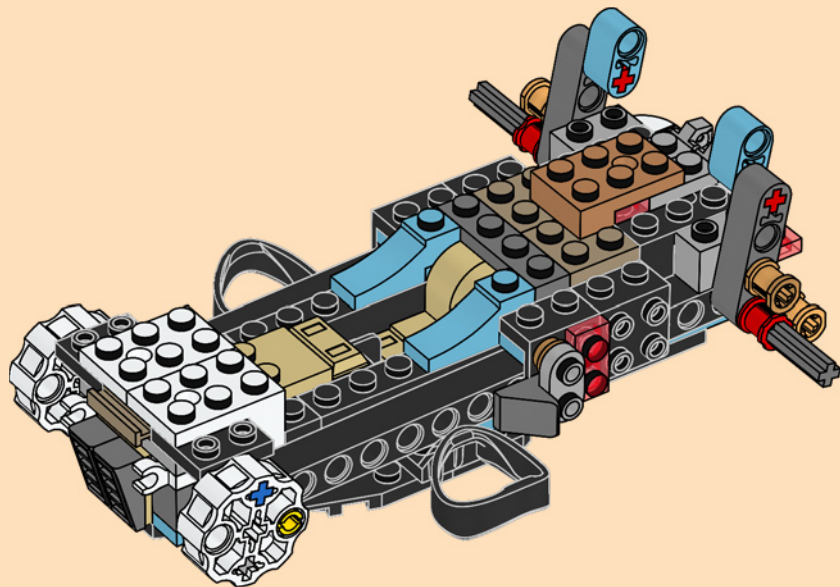

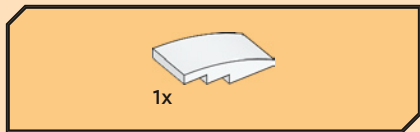

62

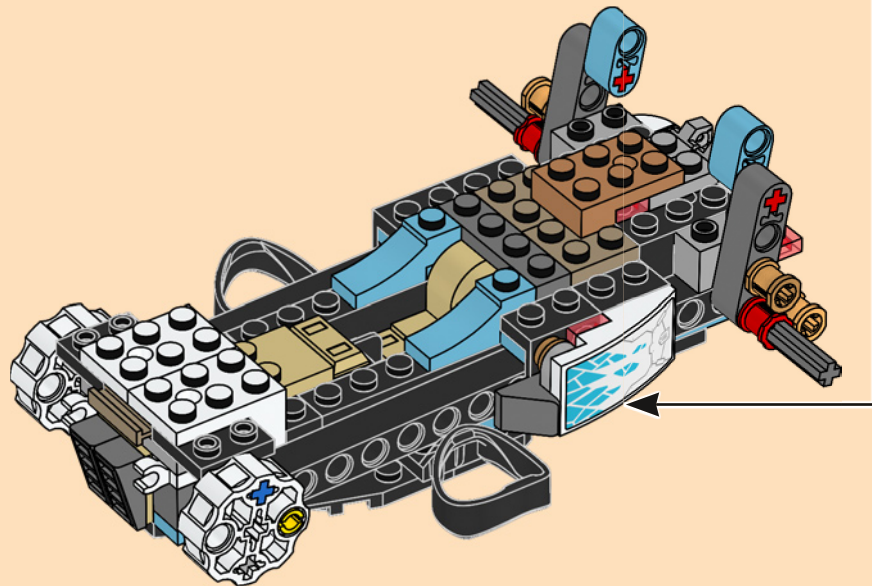
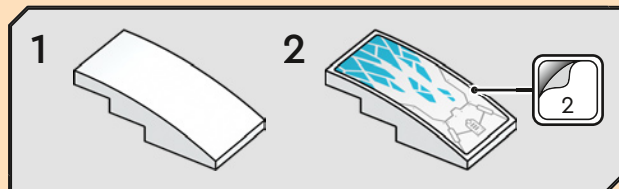

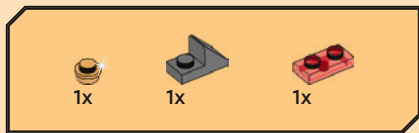

63

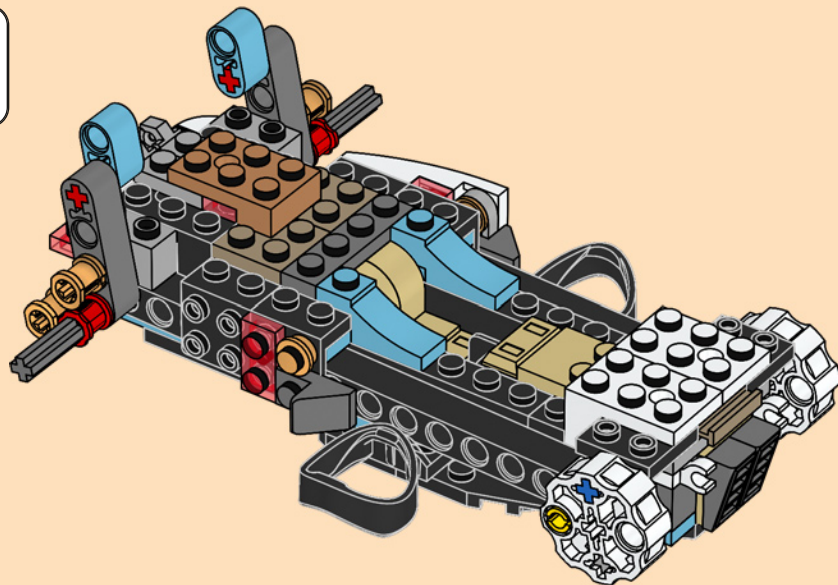



1x

64

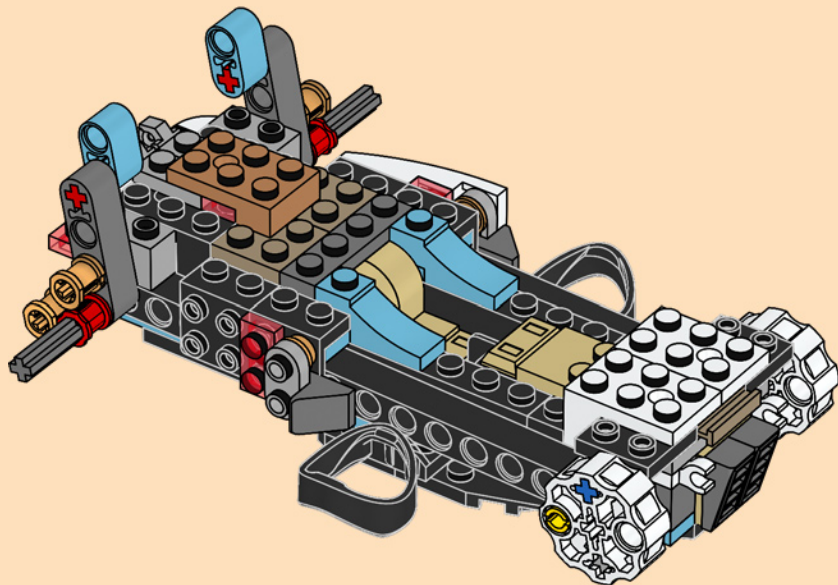

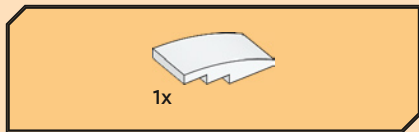

65

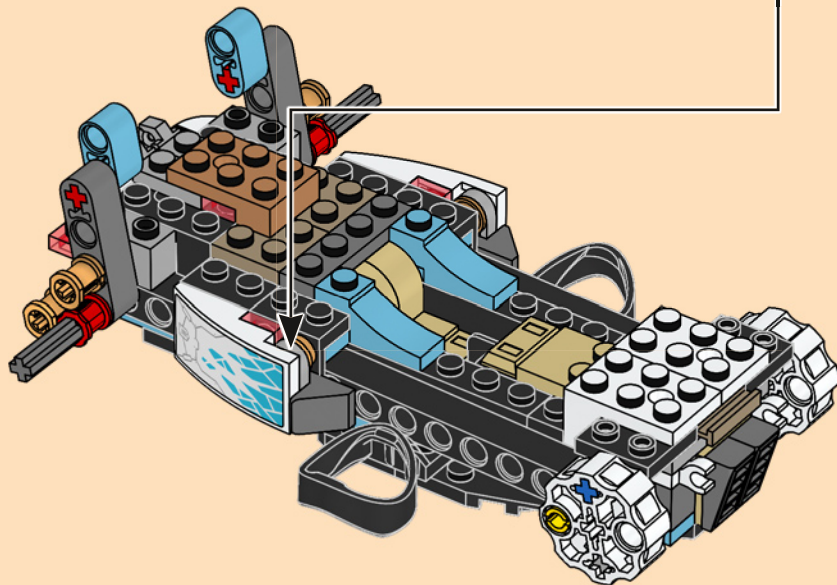
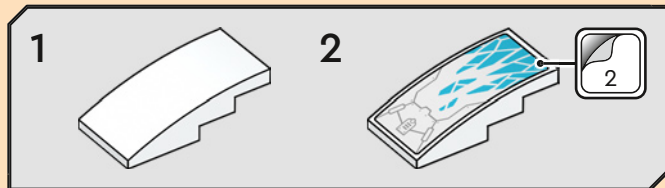

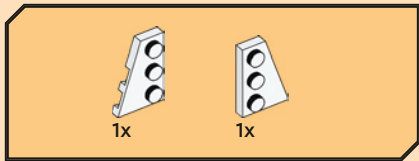

66

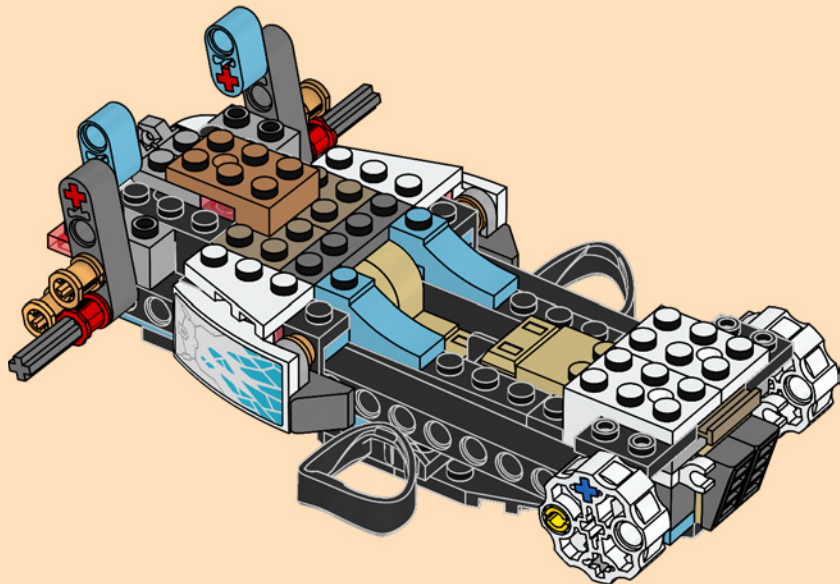



2x

67

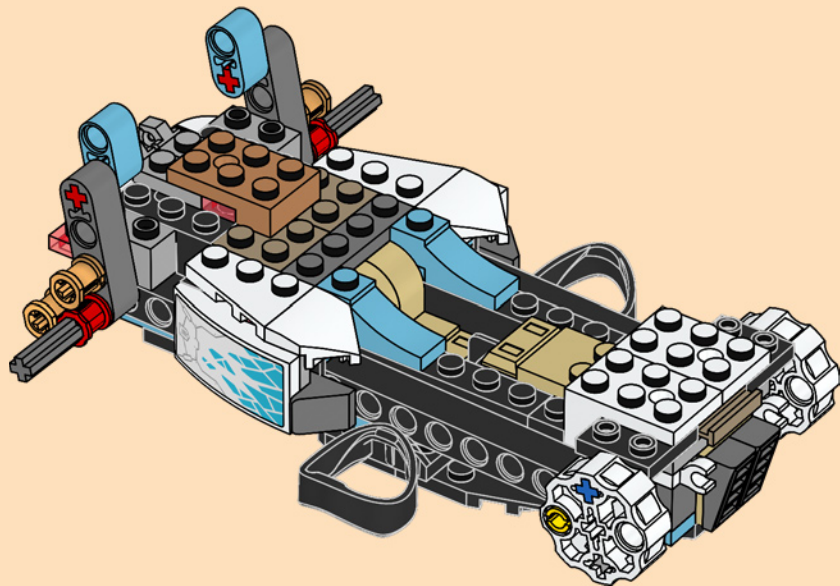

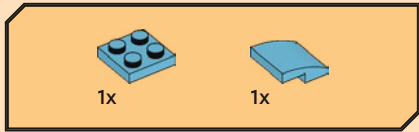

68

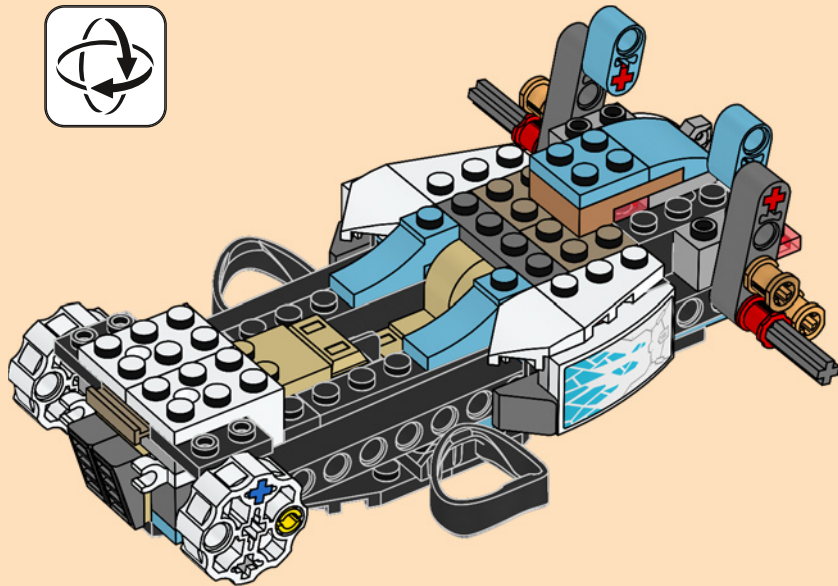

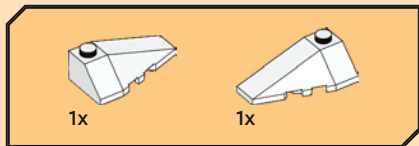

69

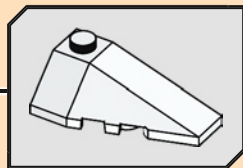
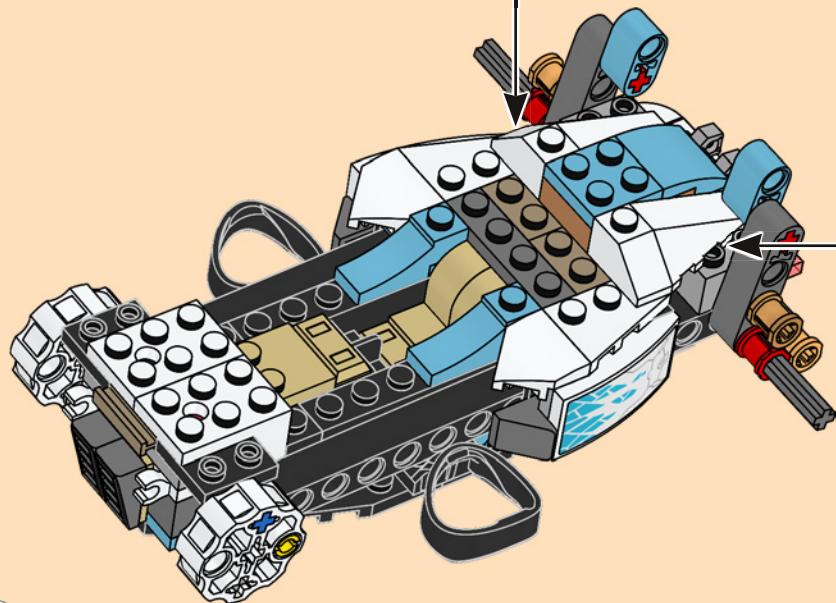
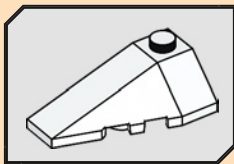

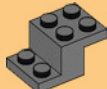

1x

70

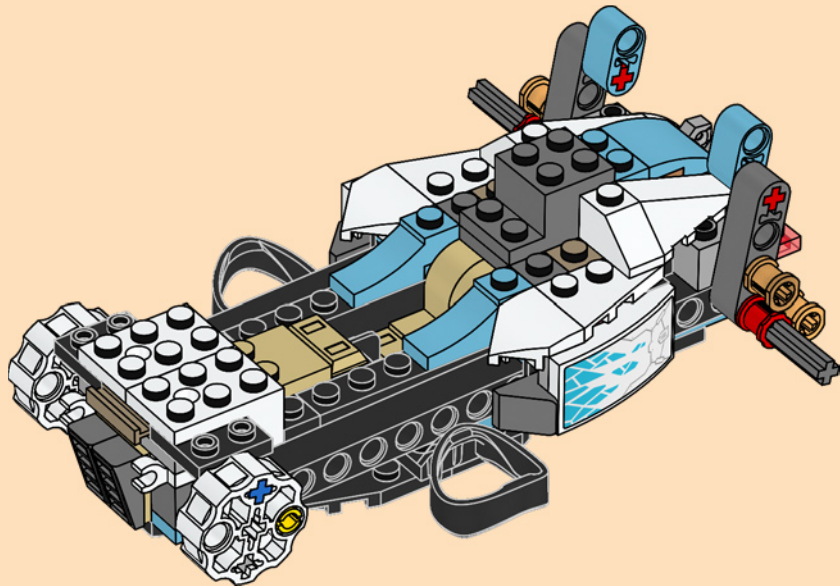

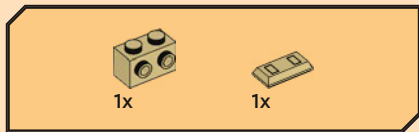

71

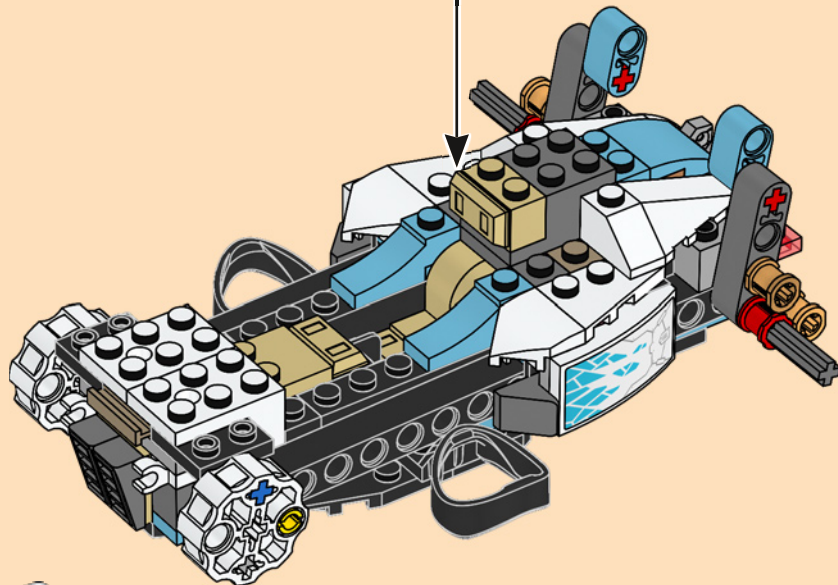
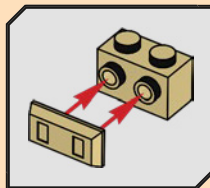



2x

72

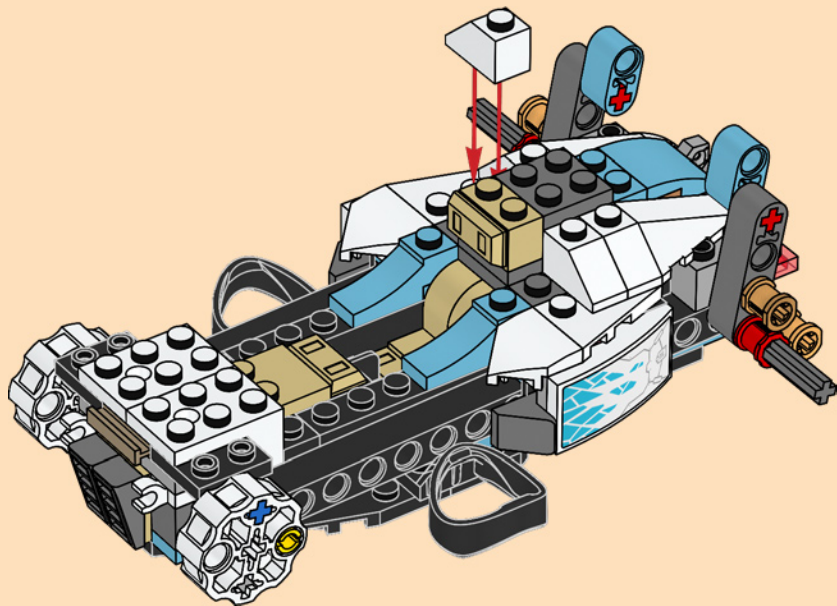



2x

73

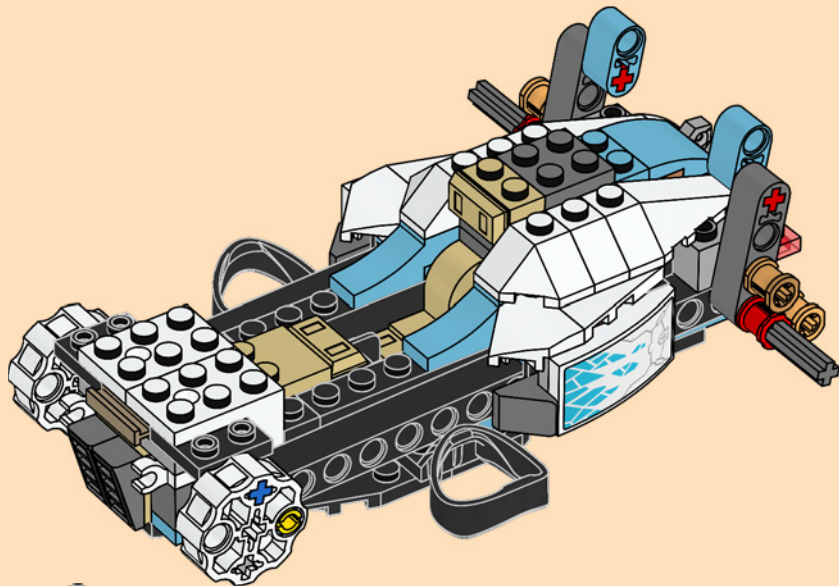



2x

74

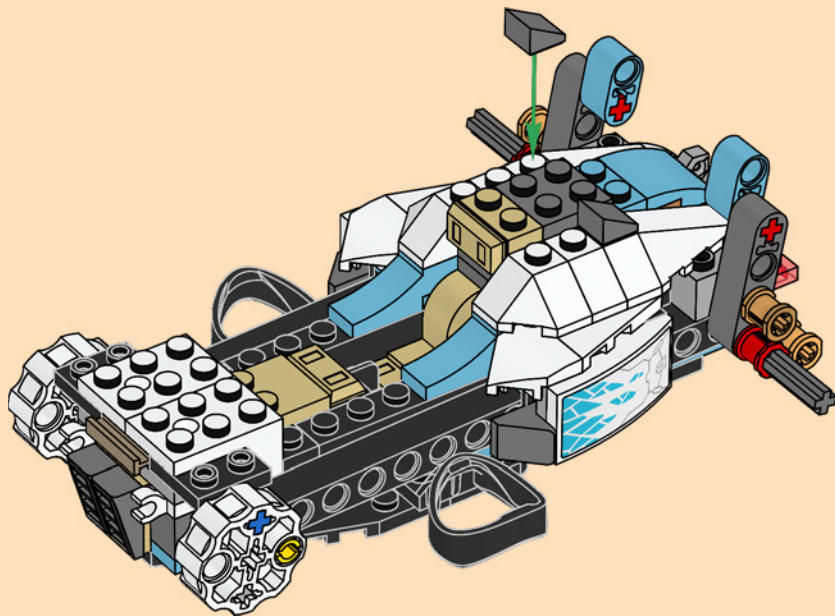



2x

75

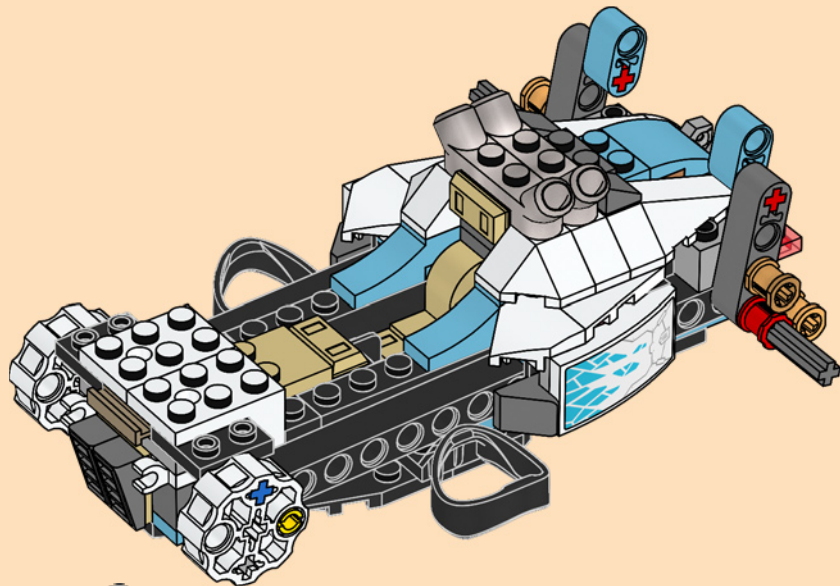



1x

76

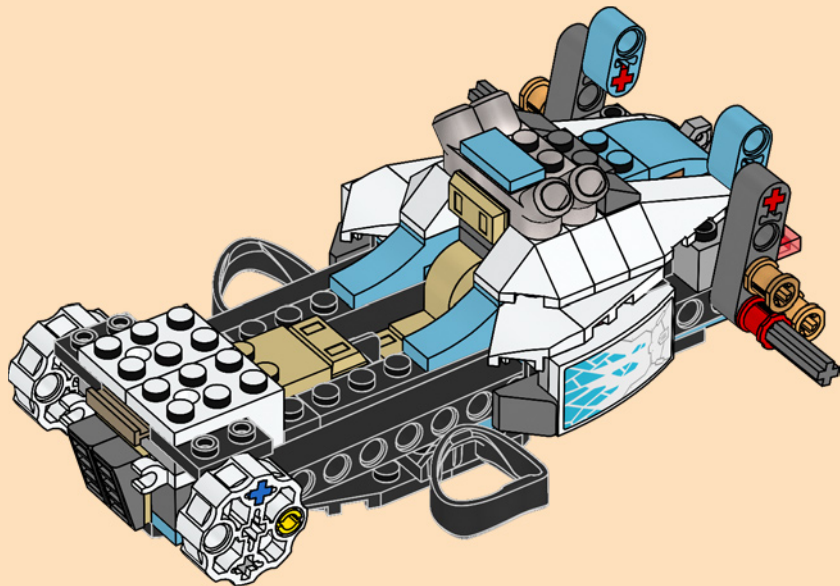

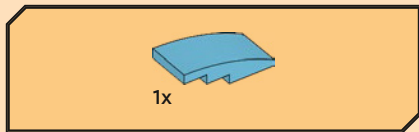

77

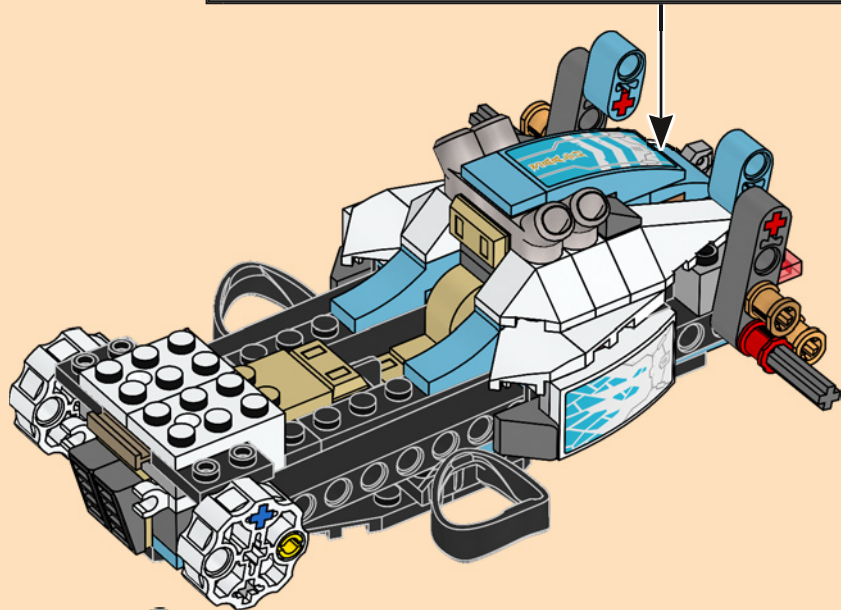
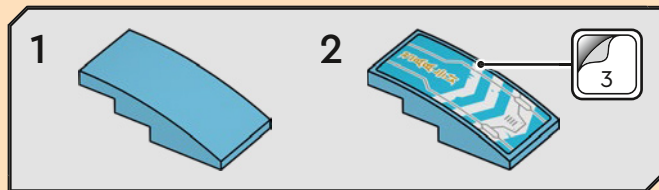

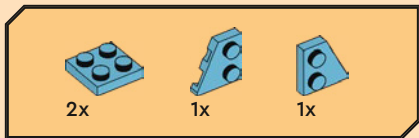

78

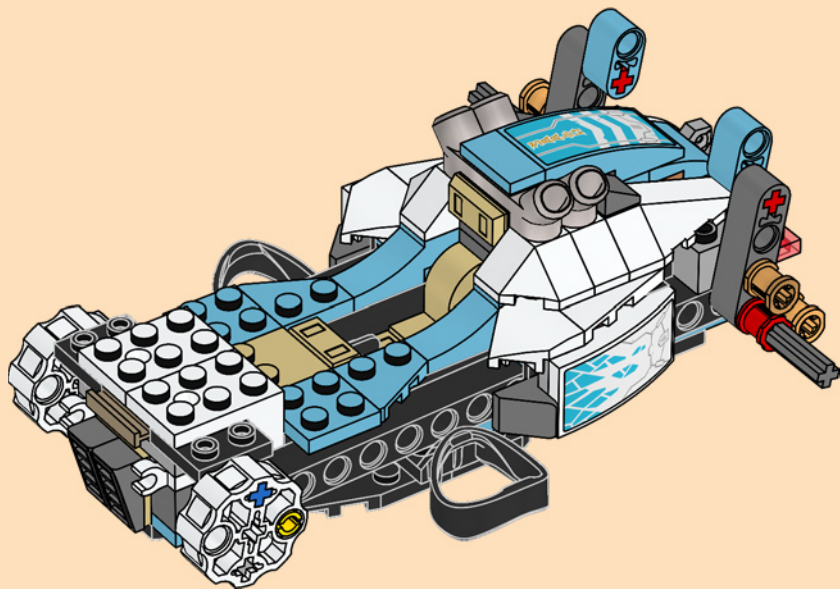

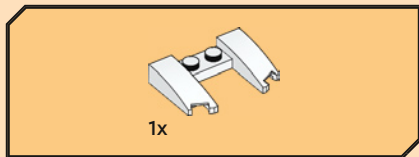

79

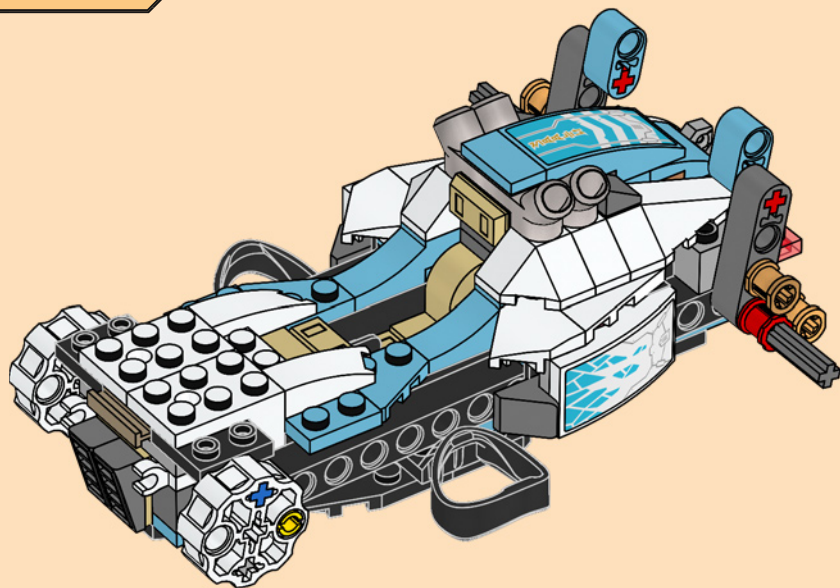



1x

80

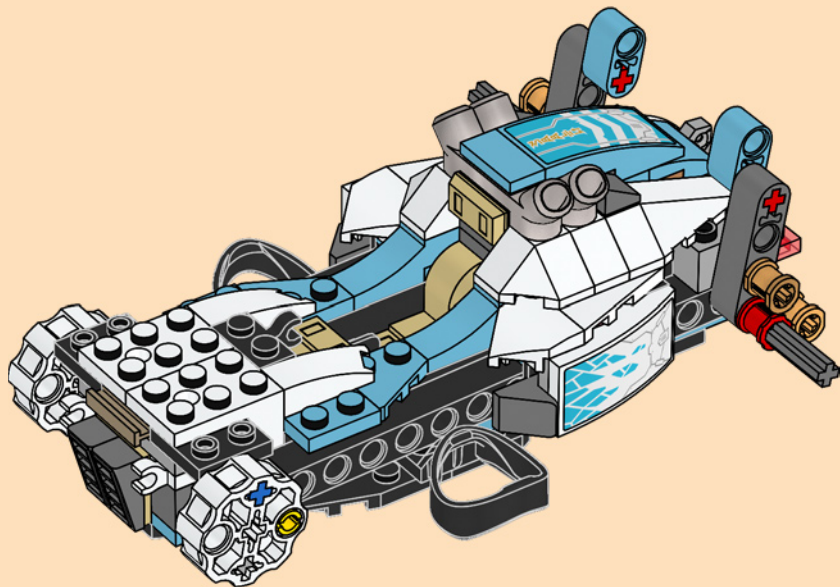



2x

81

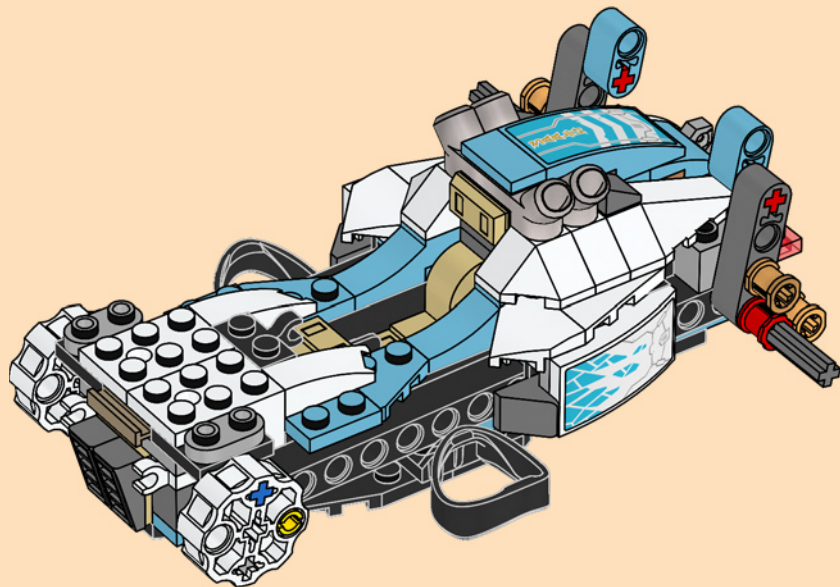

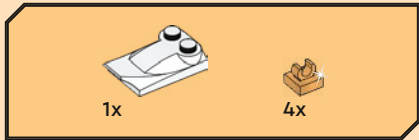

82

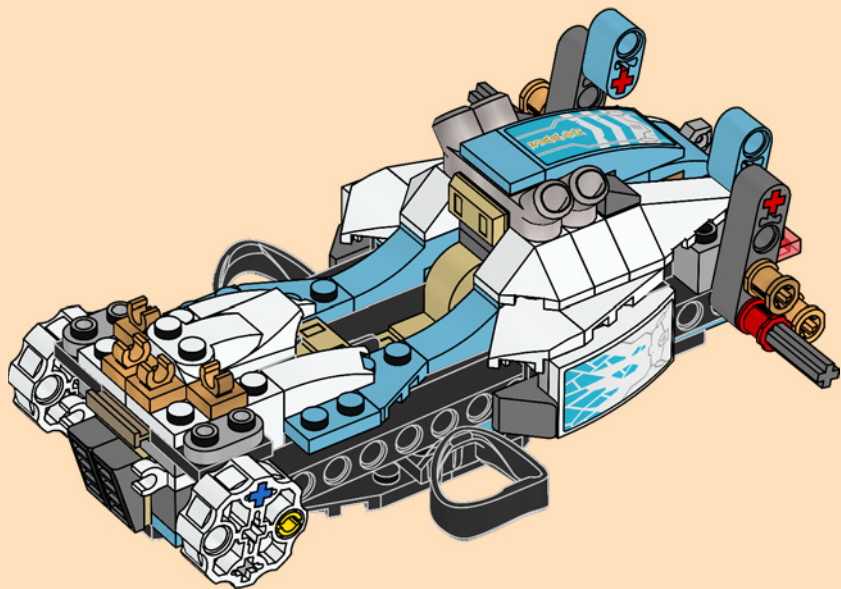



1x



1x

83

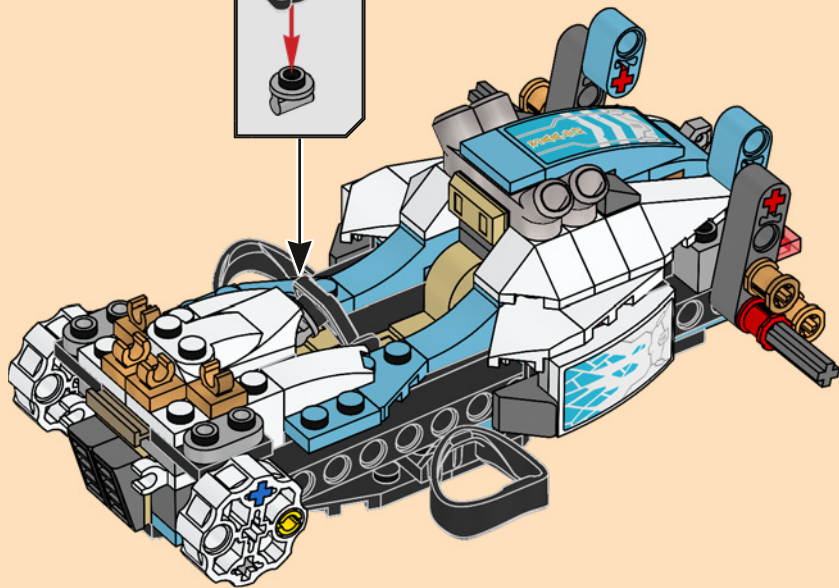
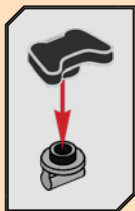

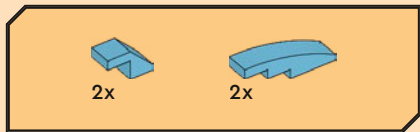

84

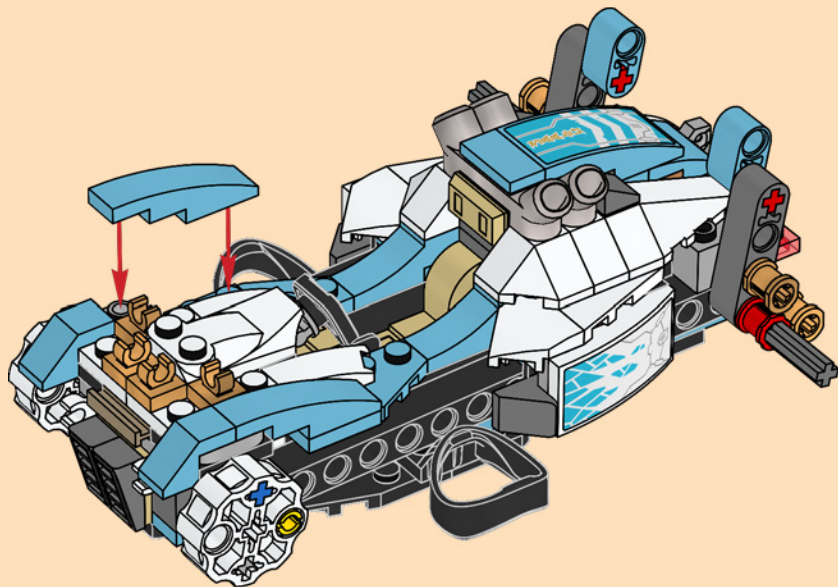

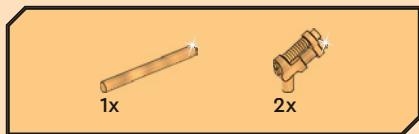

85

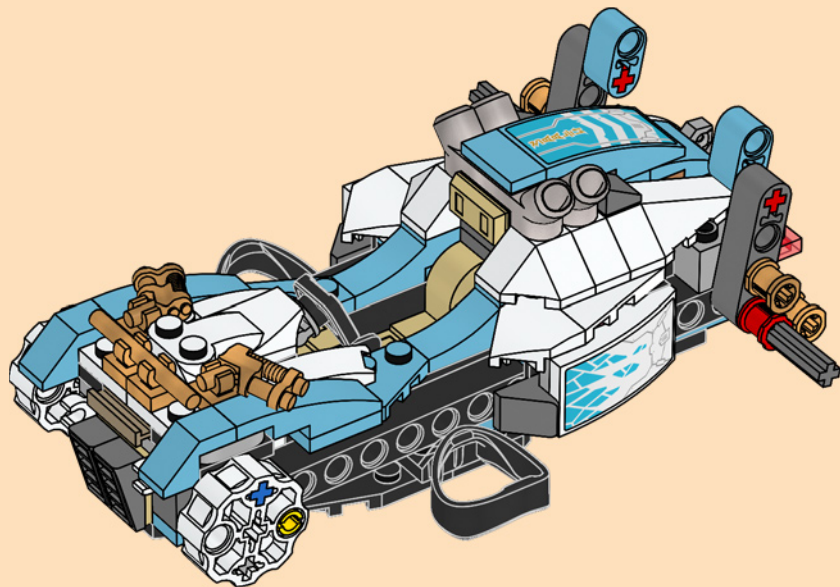



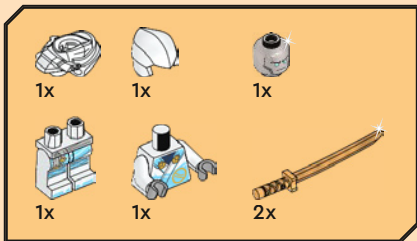

1

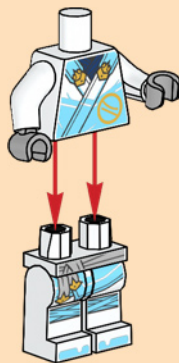

2

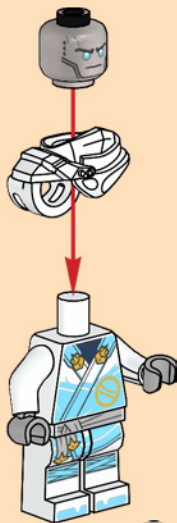

3



4



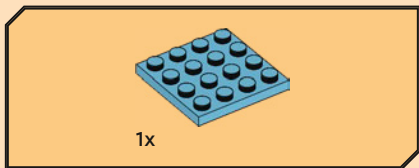
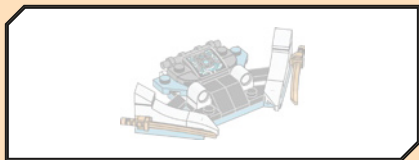

86

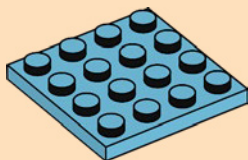



87

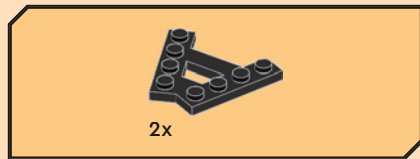
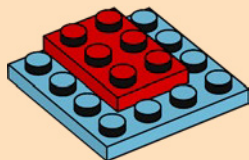

88

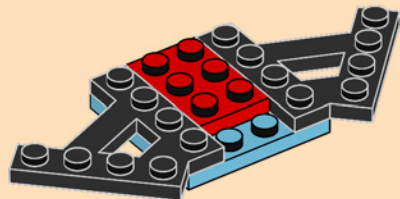

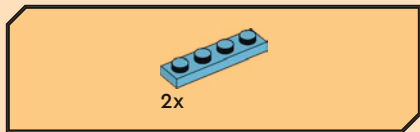

89

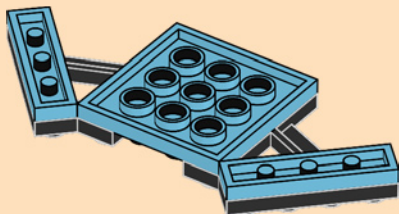

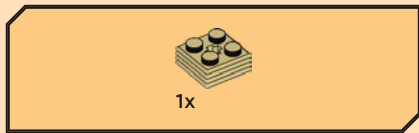

90

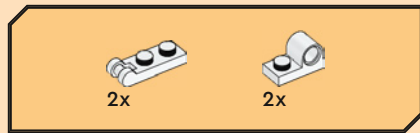
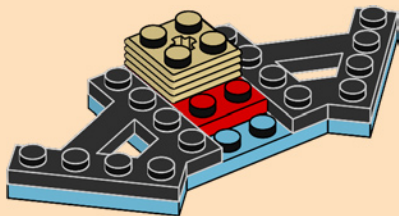

91

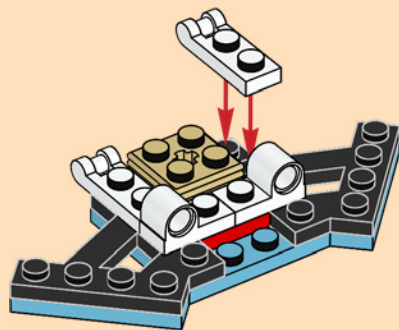



2x

92

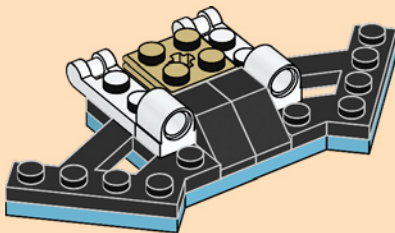



2x

93

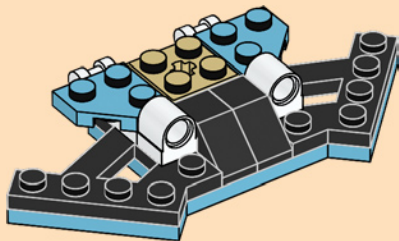

2x

94

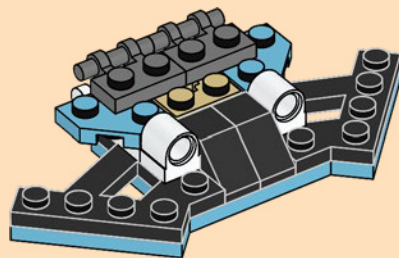



95

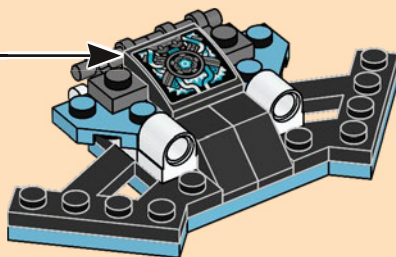
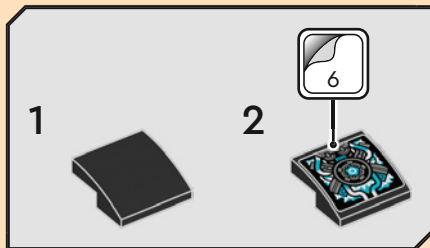



96

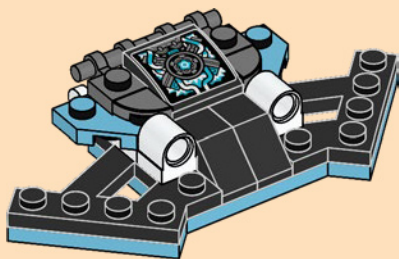

97

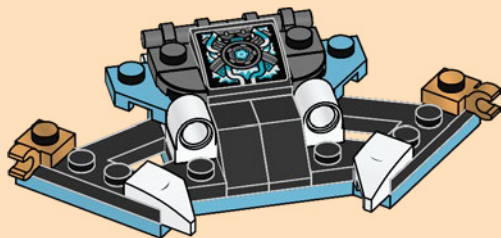



2x

98

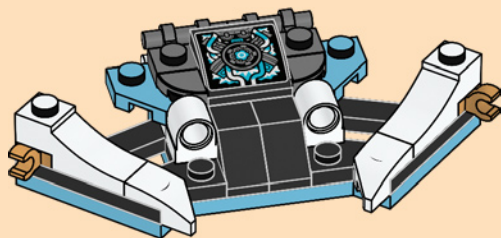



99

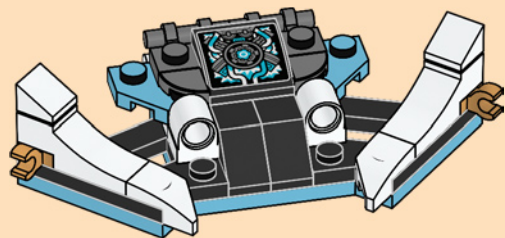

100

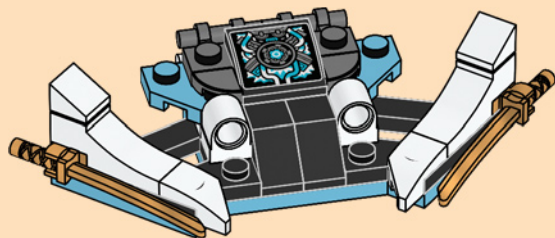

101

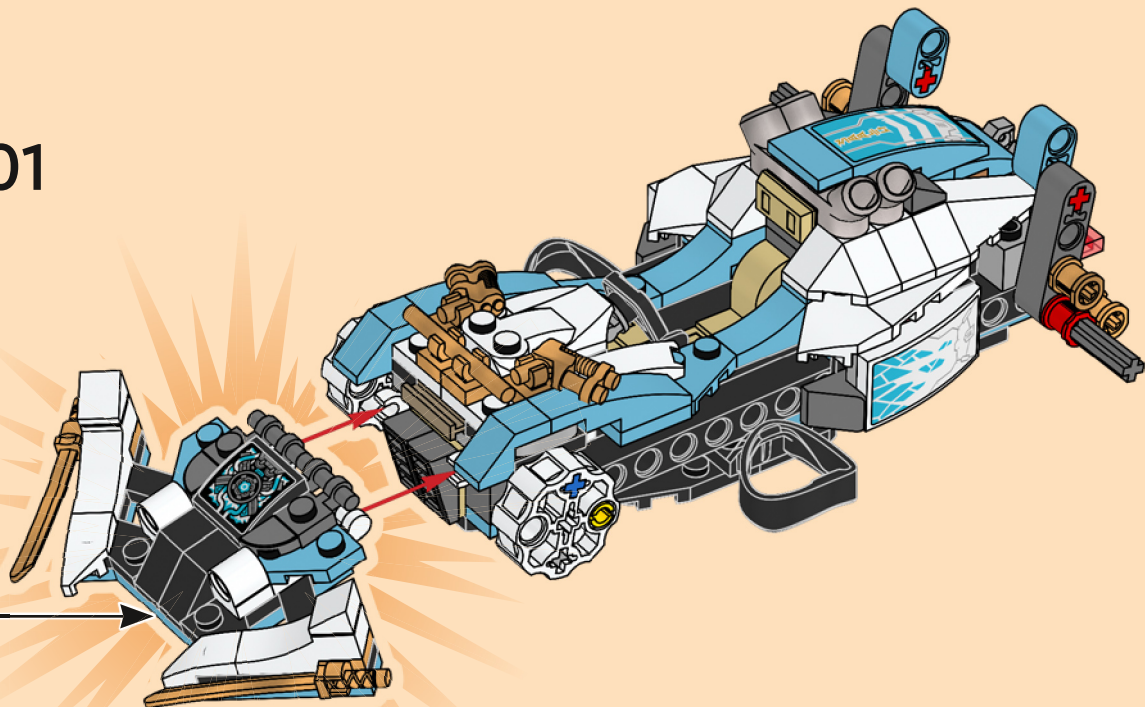

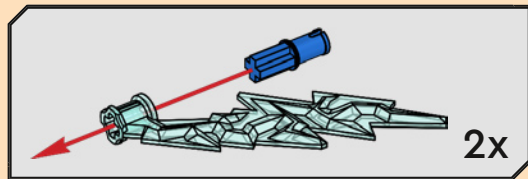
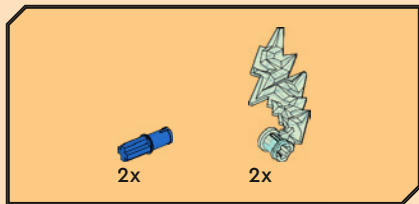

102

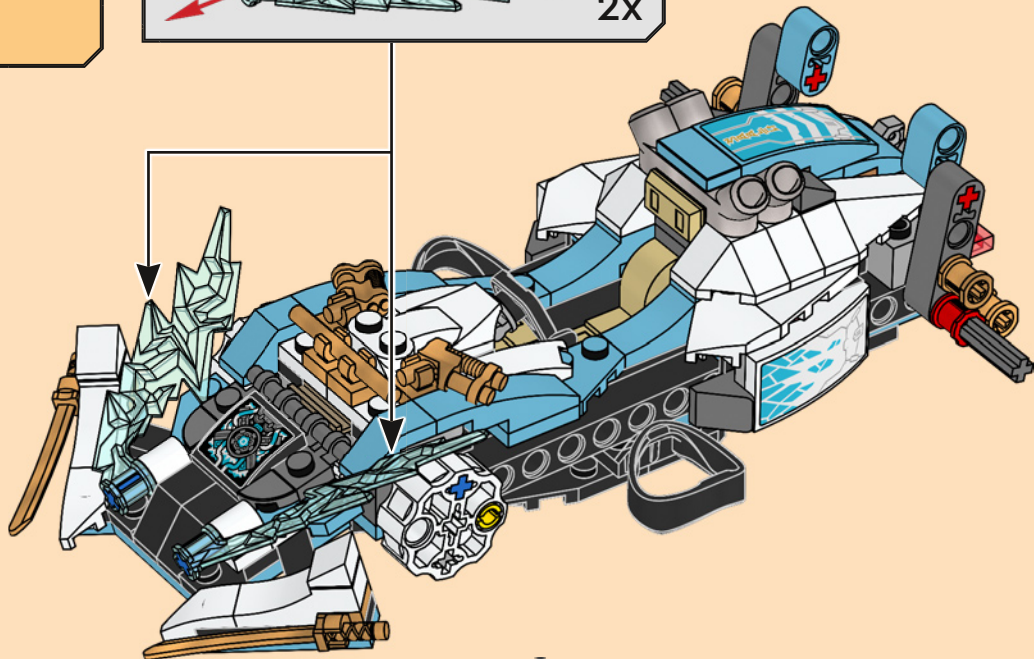

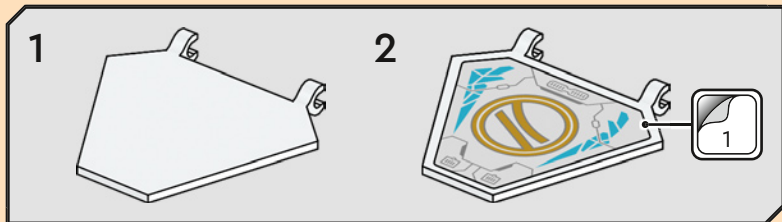
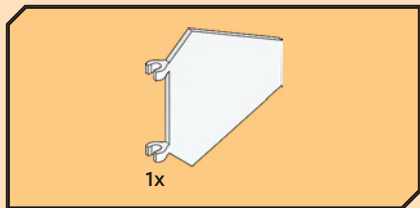

103

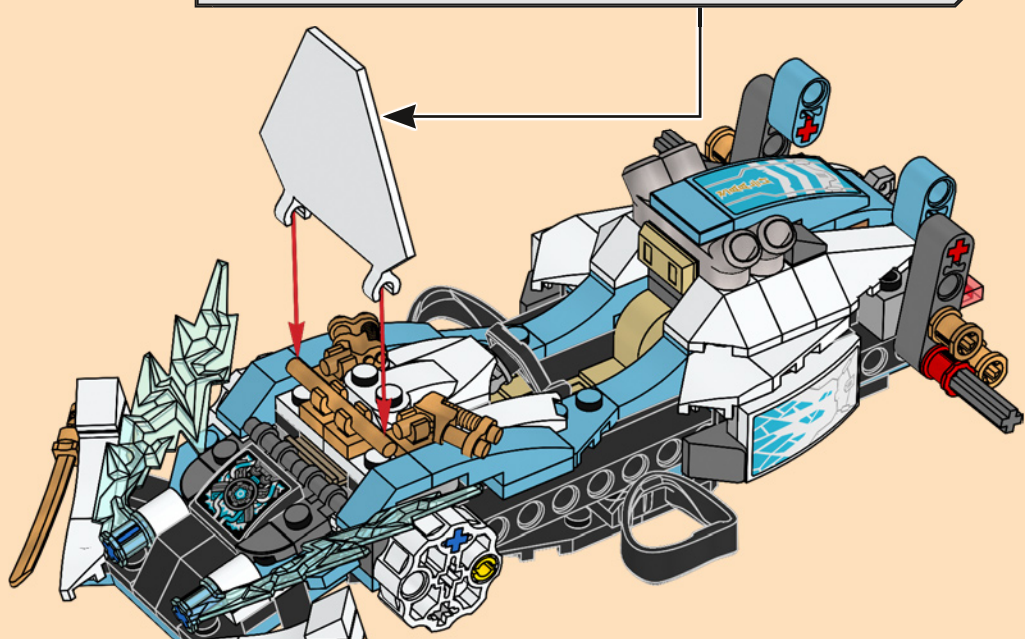

104

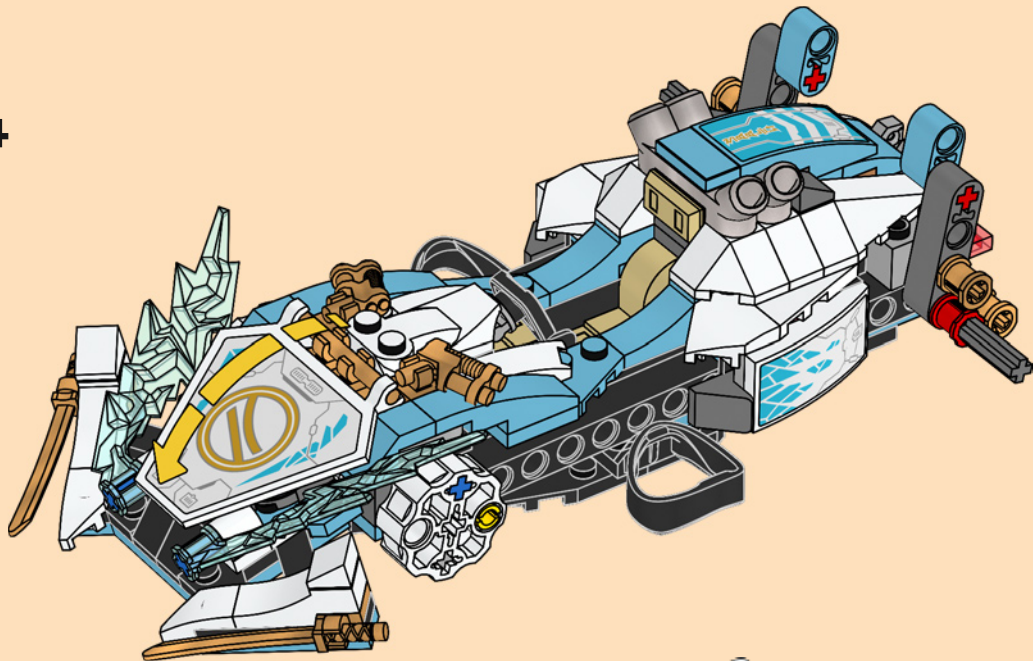



2x

105

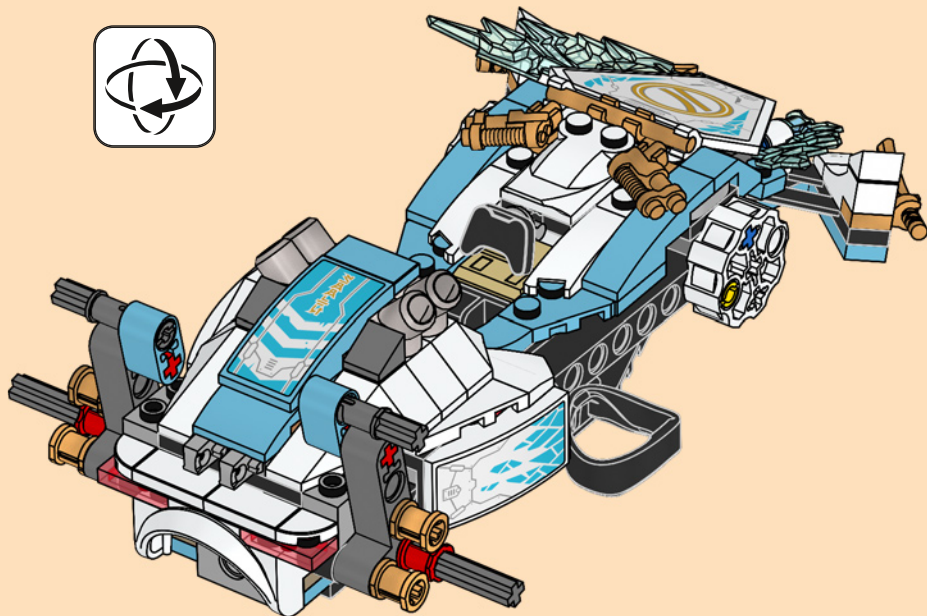

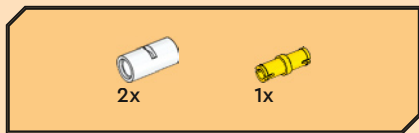

106

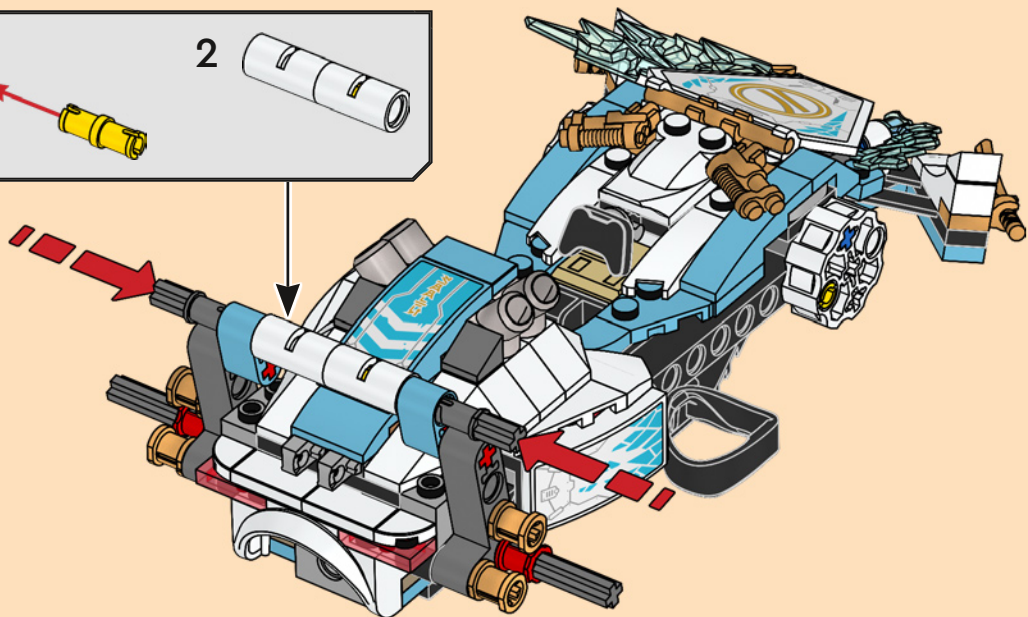
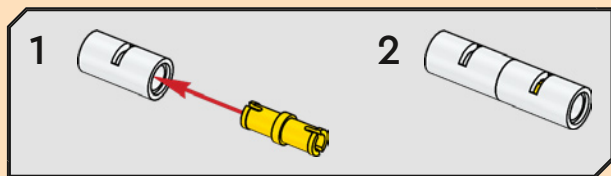

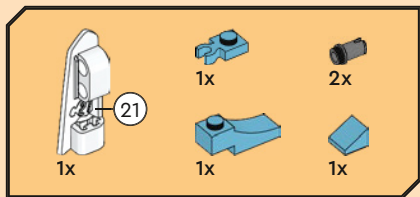

107

1

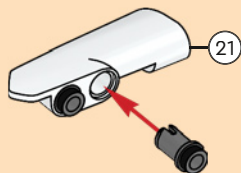

2

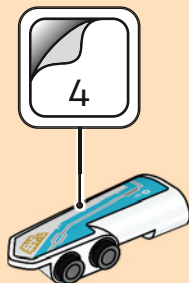

3

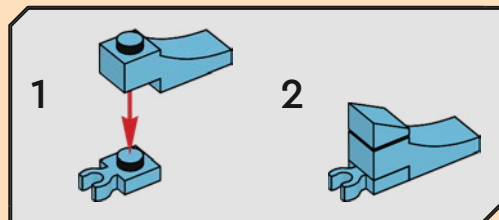
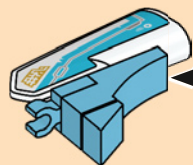

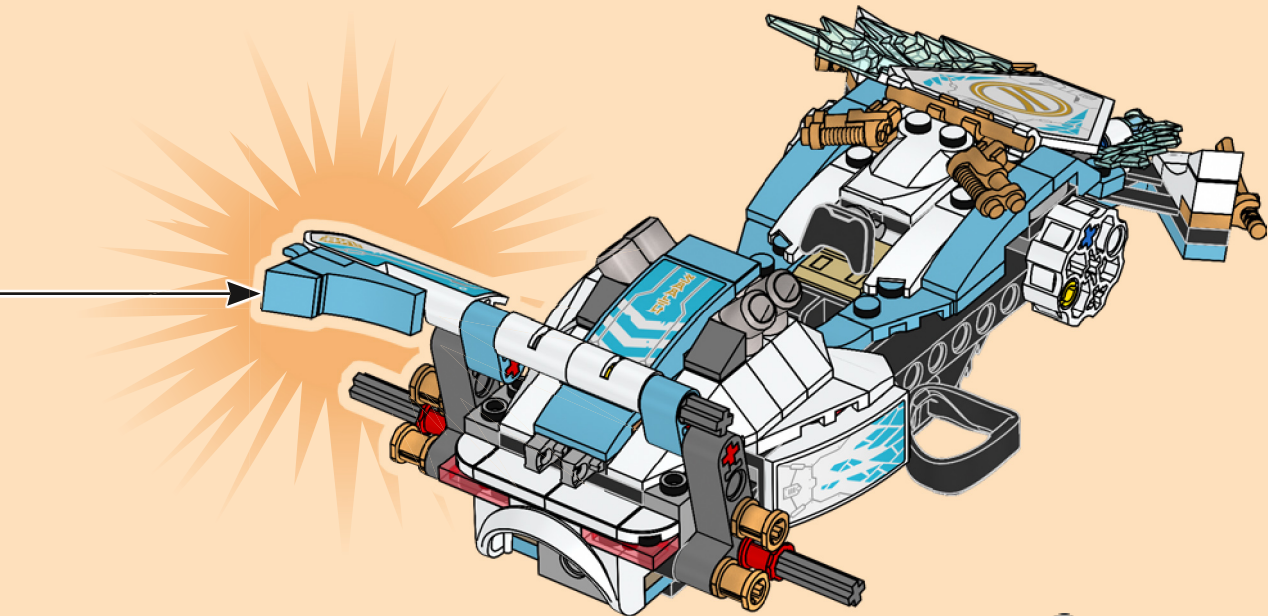

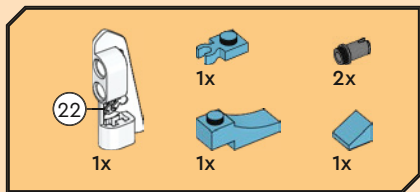

108

1

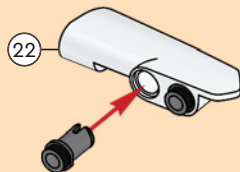

2

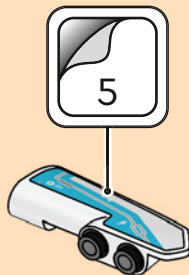

3

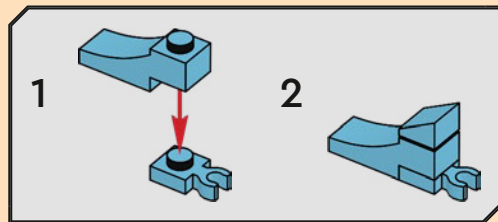
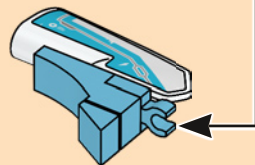

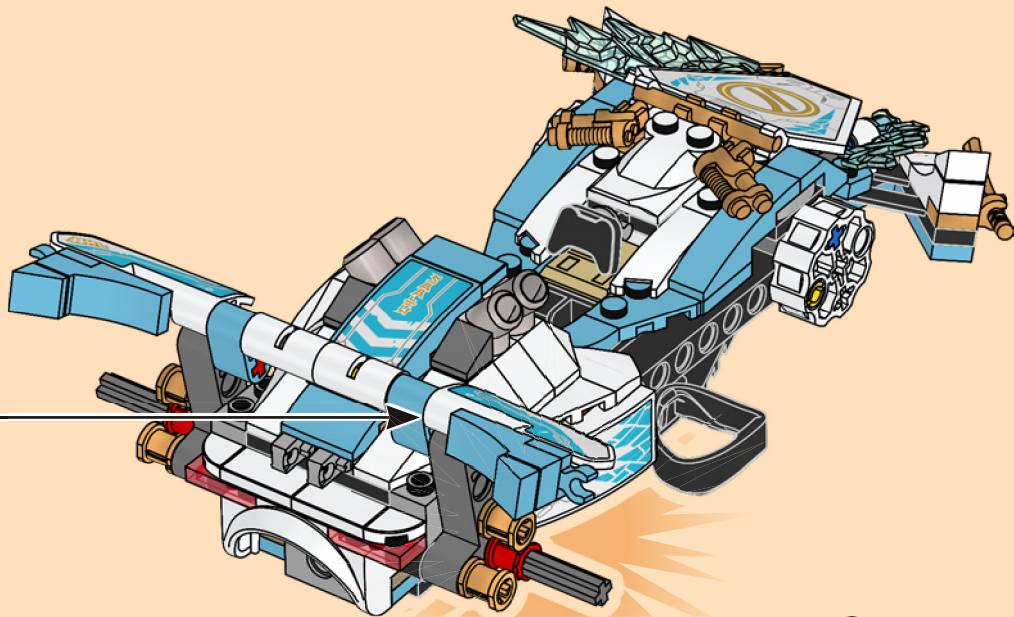

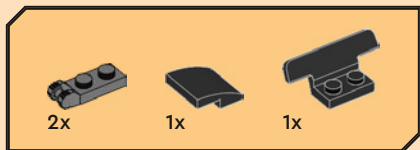

109

1

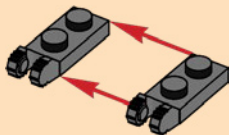

2

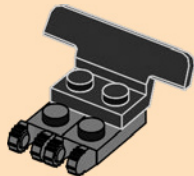

3

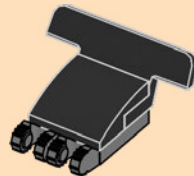

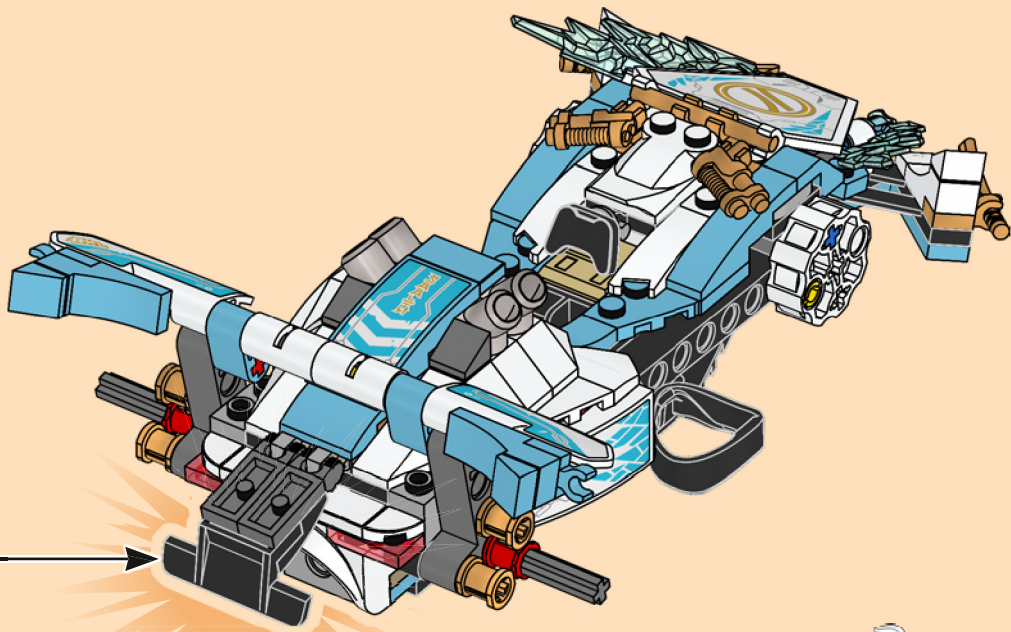

110

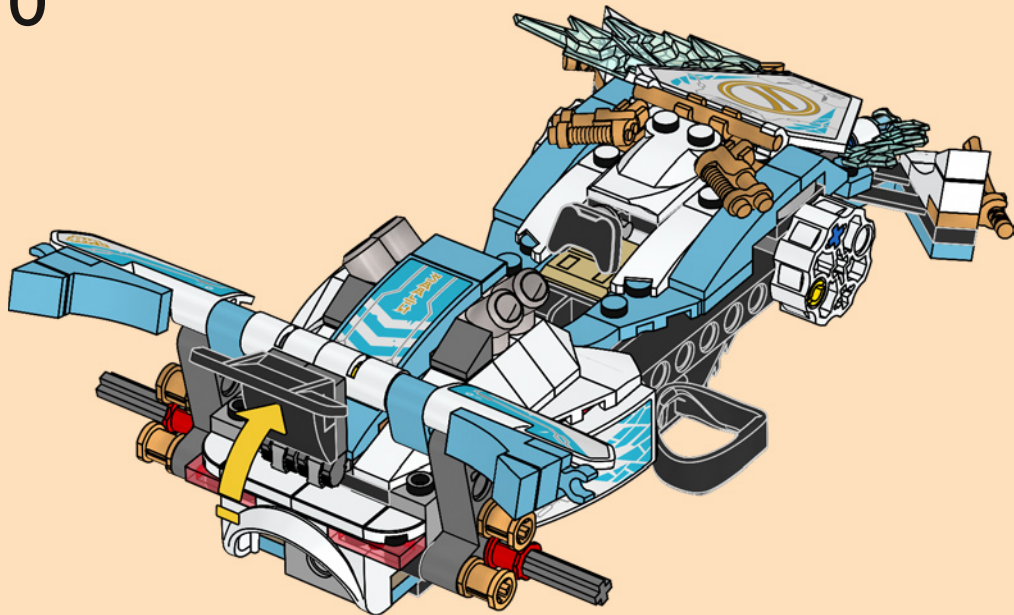

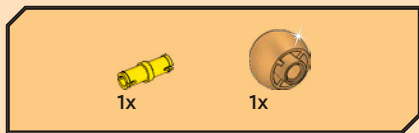

111

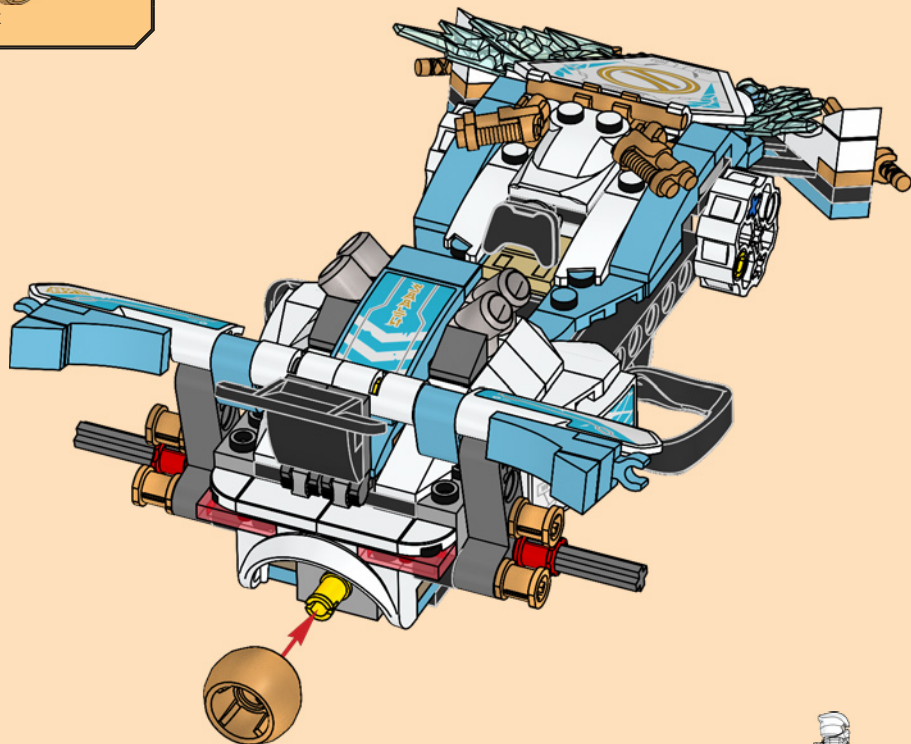

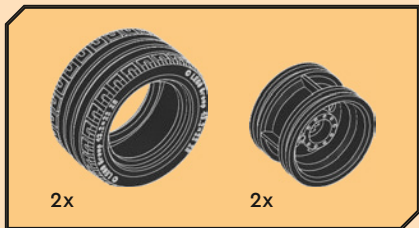

112

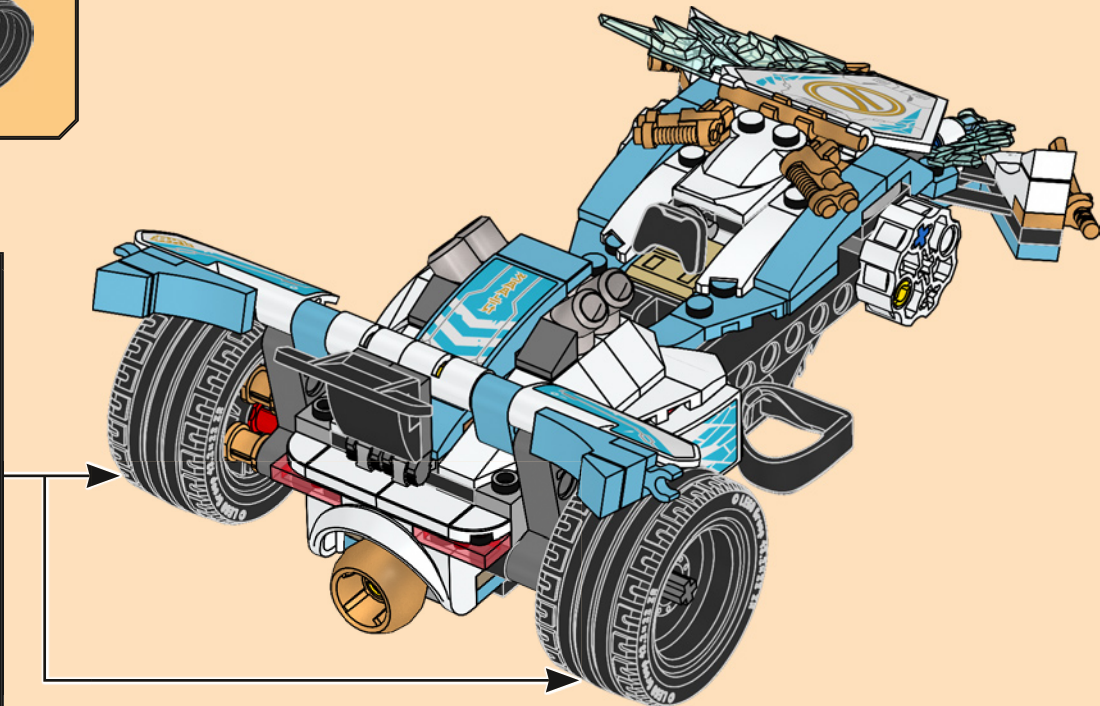
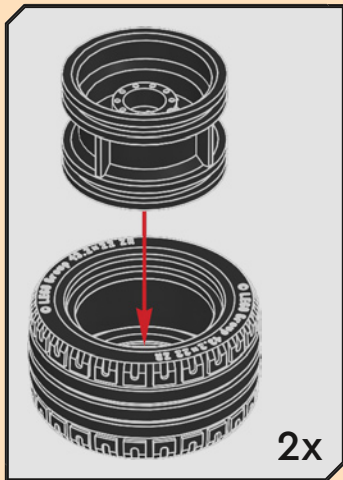



2x

113

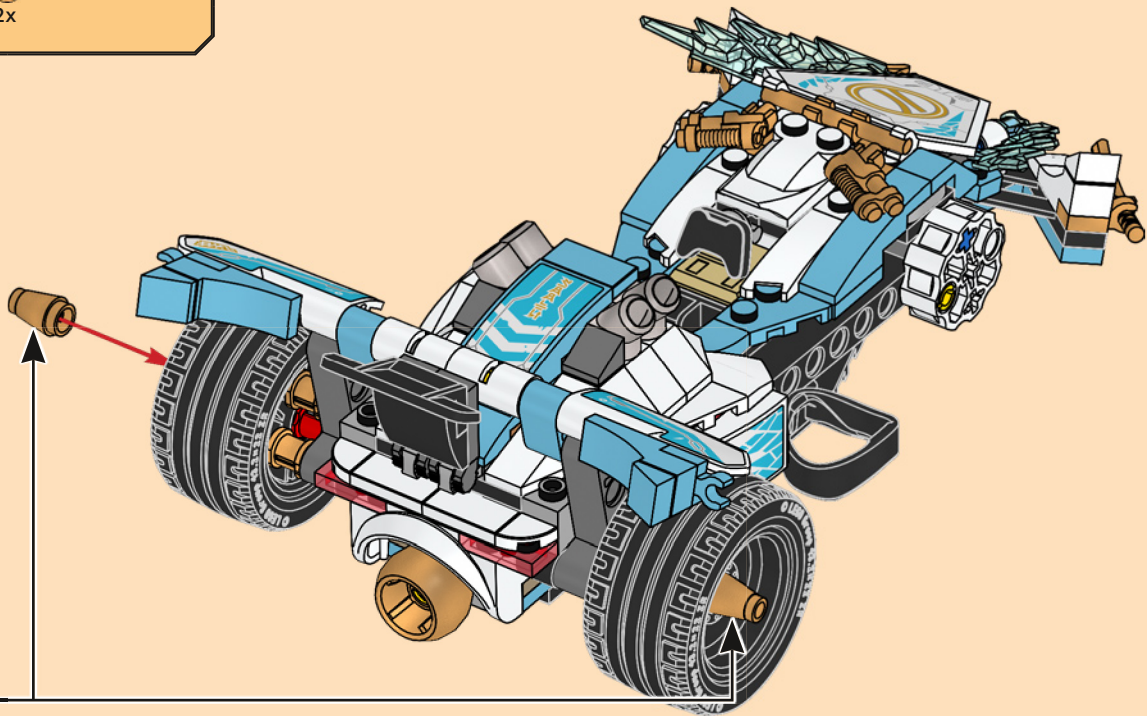

2x



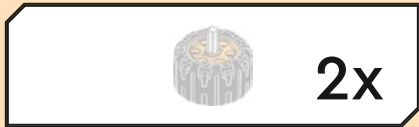

114

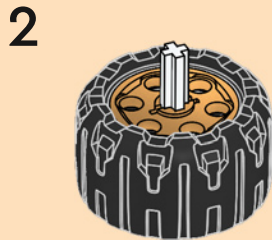
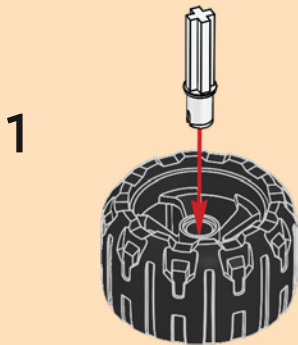

2x

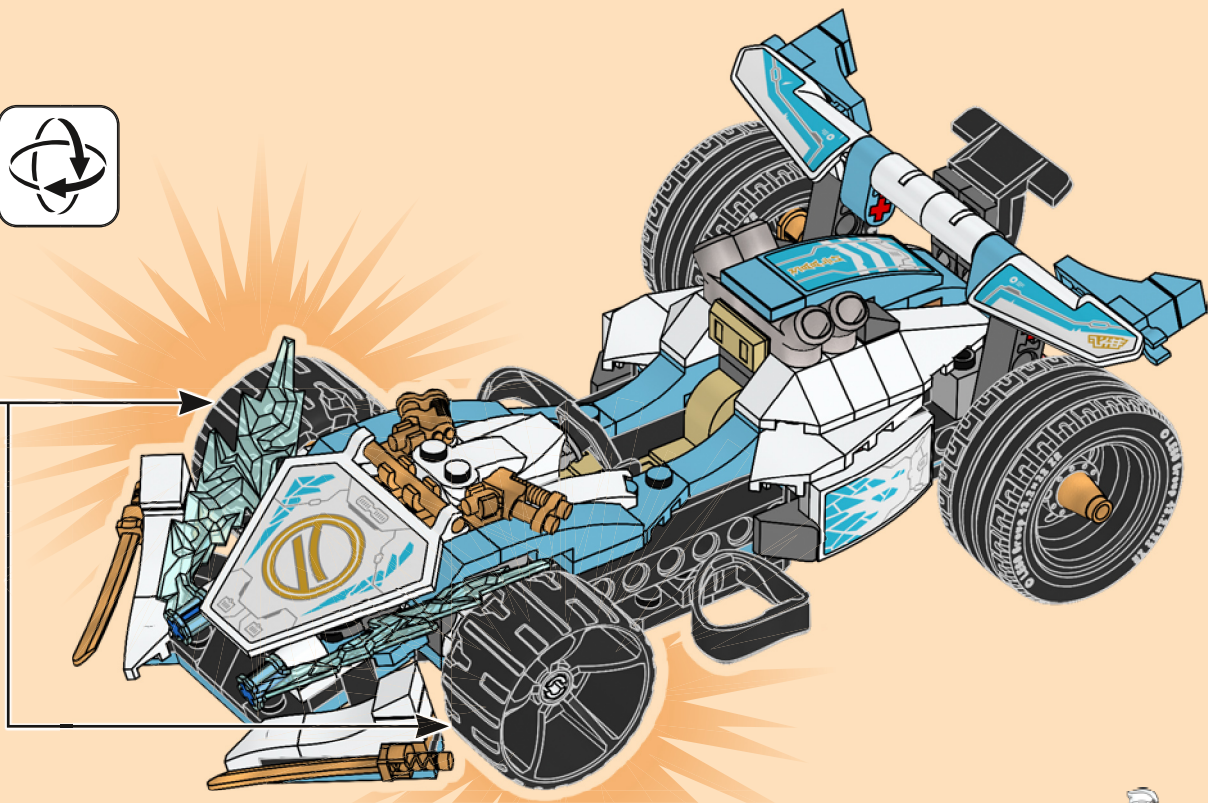



2x

115

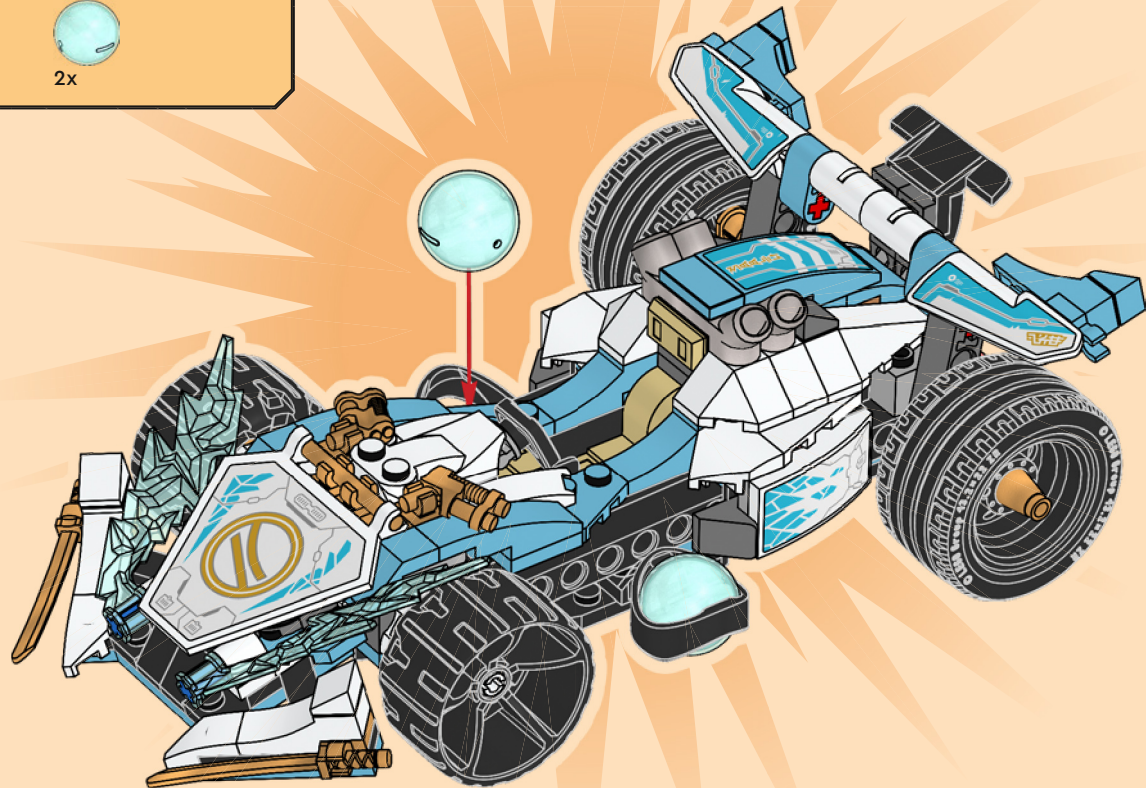

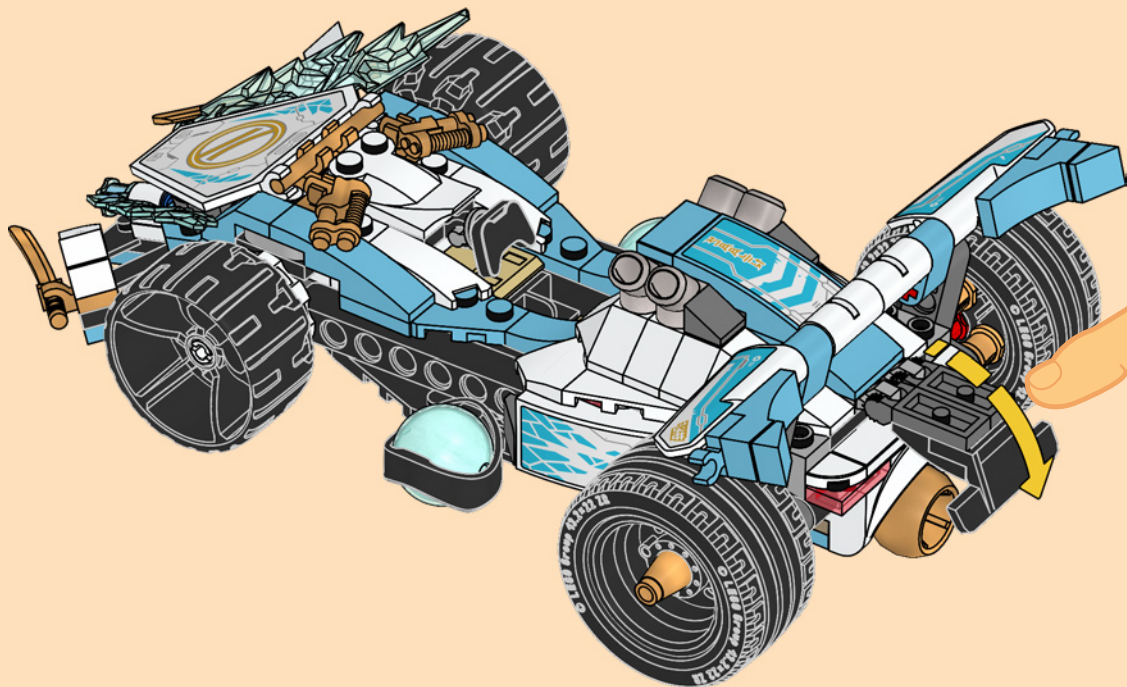

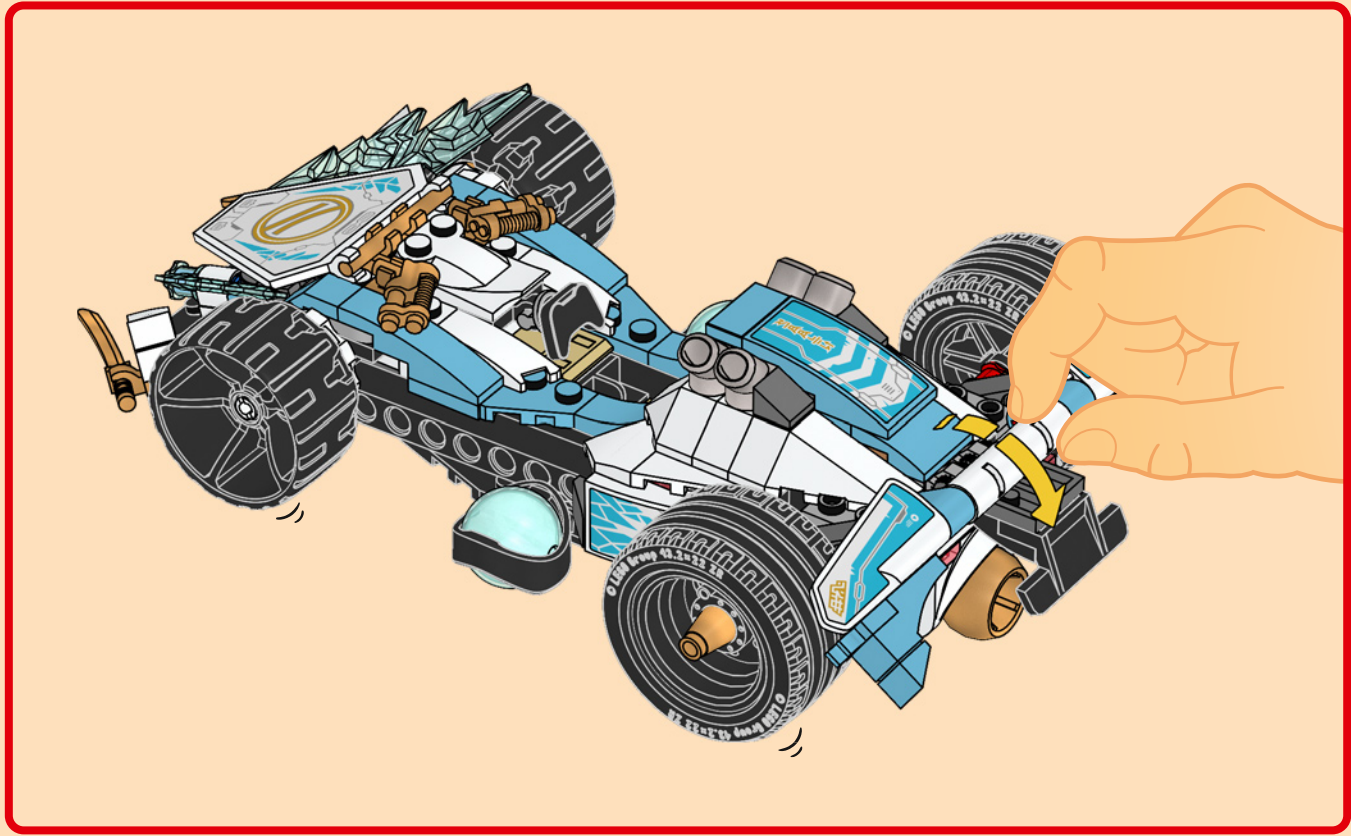

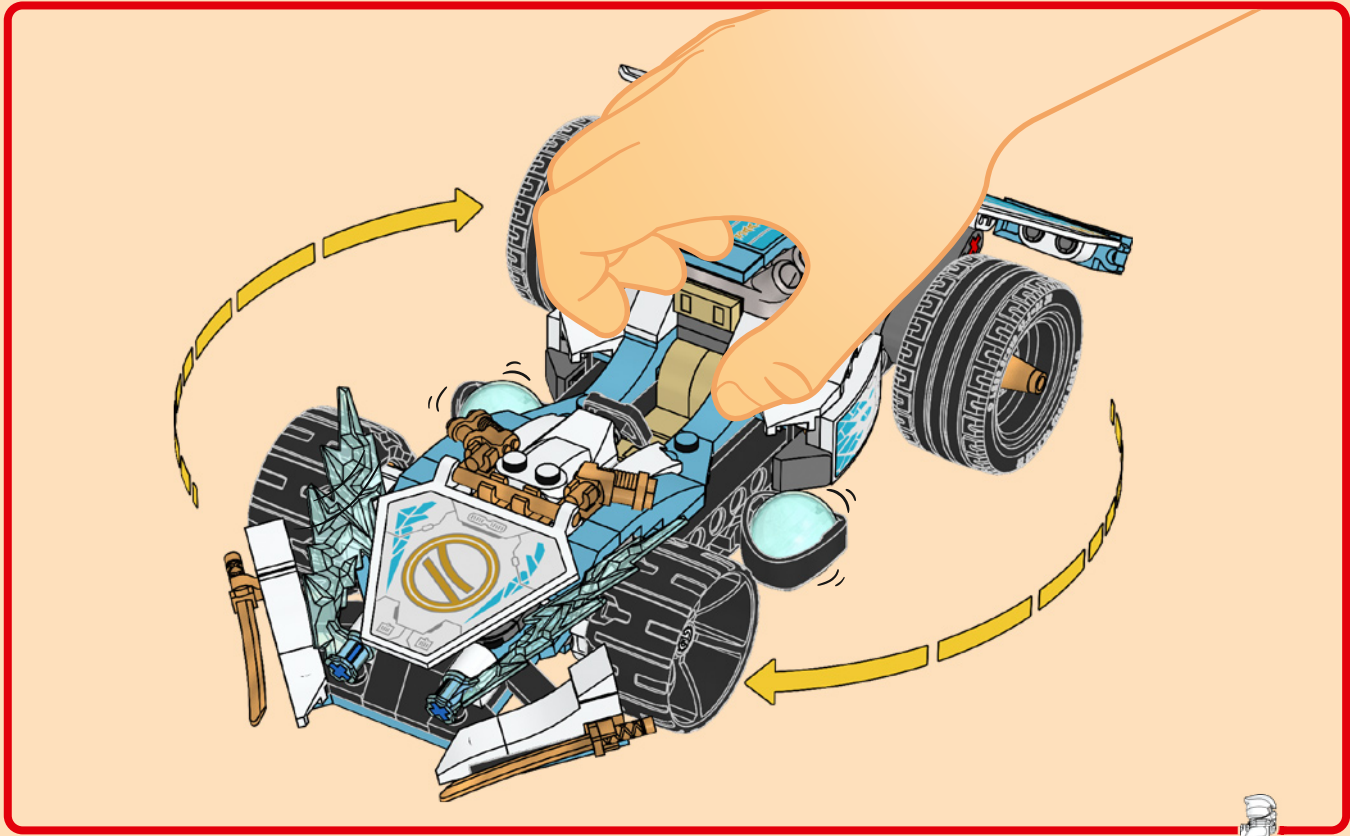



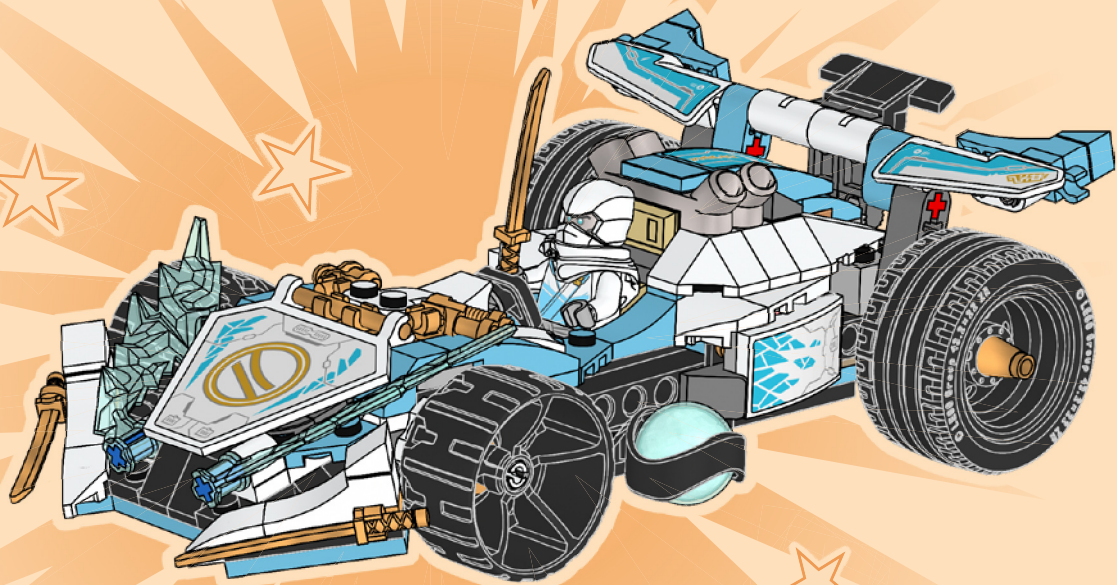



NINJAGO

DRAGONS RISING





71799



71796



71792



71793



71794

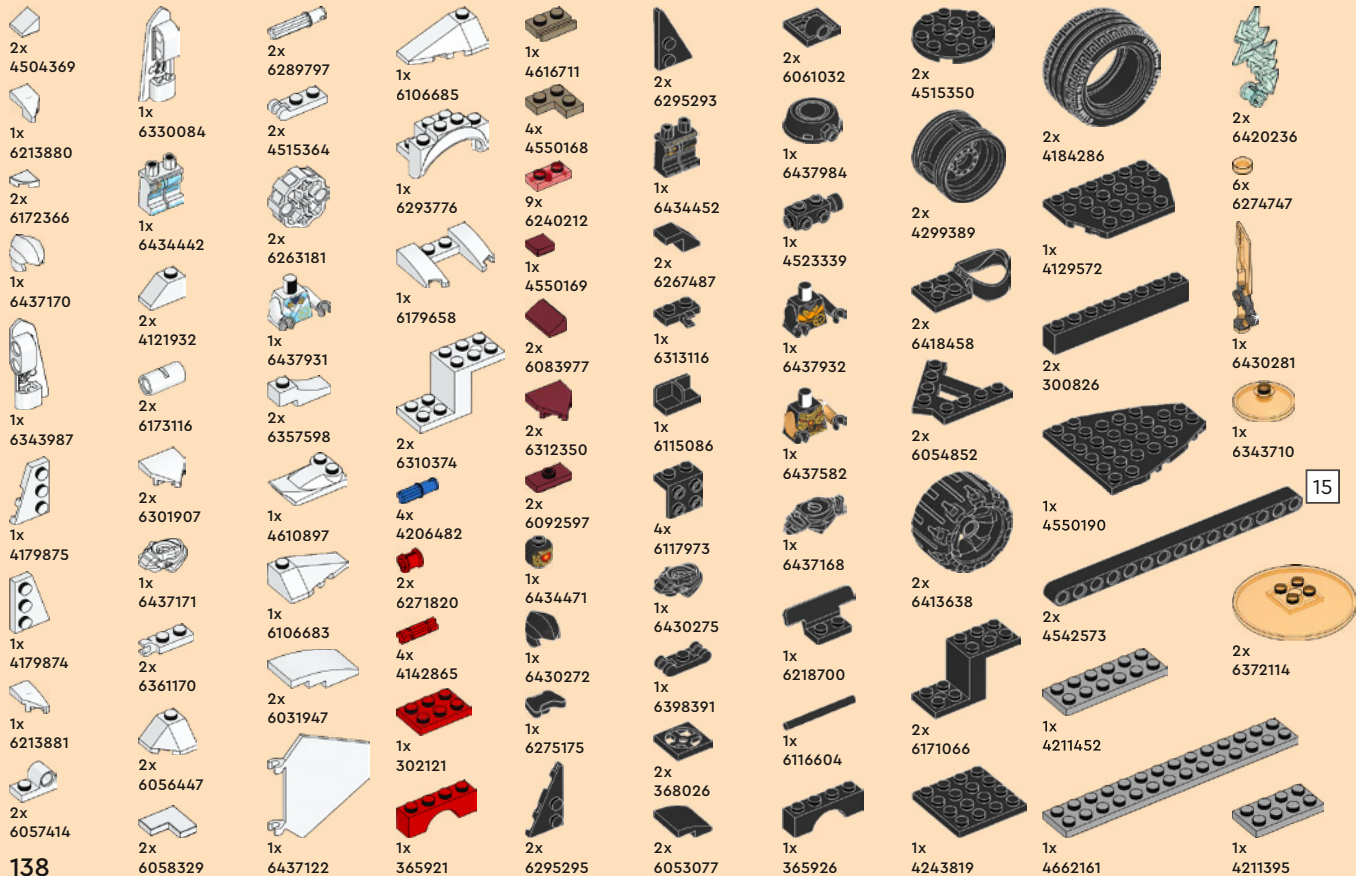

 1x 6199163	 2x 4540386	 2x 4211001	 4x 6262138	 2x 6335111	 1x 6434450	 2x 4619520	 1x 4649741	 2x 6070757
 1x 6378136	 2x 6069164	 2x 6271830	 2x 6426622	 2x 6092594	 4x 6331822	 2x 6296842	 2x 6296622	 2x 6347671
 2x 6443149	 2x 6214341	 2x 4211085	 2x 6284379	 4x 6388241	 2x 6206240	 2x 6296840	 5x 4625032	 1x 6441153
 4x 6248890	 2x 4210660	 1x 4211085	 2x 6433738	 4x 6287672	 2x 362324	 2x 645843	 1x 6119126	 6x 4625036
 2x 4540203	 2x 4211109	 2x 6218084	 1x 6434470	 1x 6437933	 1x 6024495	 2x 6249415	 4x 6320292	 1x 6141594
 2x 6266231	 2x 6015356	 1x 6287680	 1x 6434474	 1x 6430283	 3x 6271228	 2x 4632100	 2x 6344440	
 3x 6326478	 2x 6267047	 1x 6003147	 1x 6434474	 1x 6147169	 2x 6411329	 2x 6344440		
 2x 6439405	 2x 4225733	 1x 6395363	 1x 6403912	 2x 6270138	 1x 6117975			
 2x 6231765	 2x 4529247	 2x 4523159	 1x 6430284	 6x 6116596	 1x 6330903			
 4x 6395635	 1x 6395363	 2x 4523159	 1x 6430284	 6x 6116596	 1x 6330903			
 2x 6199549	 2x 6083620	 1x 6434472	 2x 6323675	 1x 6175943	 2x 6221467			
 2x 4504378								

4

[LEGO.com/service](https://www.LEGO.com/service)

YOU COULD
WIN



Scan this QR code or go to
LEGO.COM/PRODUCTFEEDBACK and give us
your short feedback about this LEGO® set for
a chance to win a cool LEGO prize.

Terms and Conditions apply*



EN: YOU COULD WIN. Terms and Conditions apply* **DE: Du könntest GEWINNEN.** Es gelten die Teilnahmebedingungen* **FR: Tu pourrais GAGNER.** Des conditions s'appliquent* **IT: Potresti VINCERE tu.** Termini e condizioni sono applicabili* **ES: Puedes GANAR.** Aplican términos y condiciones* **PT: Poderá GANHAR.** Aplicam-se termos e condições* **ZH: 轻松获奖. 条款和条件适用*** **PL: Szansa na WYGRANĄ.** Obowiązują warunki korzystania* **CS: Máte šanci VYHRÁT.** Platí všeobecné smluvní podmínky* **SK: Máte šancu VYHRAŤ.** Platia všeobecné zmluvné podmienky* **HU: TE IS NYERHETSZ.** Felhasználási feltételek érvényesek* **RO: Ai putea CÂȘTIGA.** Se aplică termenii și condiții* **BG: Можете да СПЕЧЕЛИТЕ.** Има определени правила и условия* **LV: Tu vari LAIMĒT.** Ir spēkā noteikumi un nosacījumi.* **ET: Sul on võimalus VÕITA.** Kehtivad tingimused* **LT: Jūs galite LAIMĖTI.** Taikomos sąlygos*

*[LEGO.com/productfeedback-terms](https://www.lego.com/productfeedback-terms)

LEGO, the LEGO logo, NINJAGO and the NINJAGO logo are trademarks of the/son des marques de commerce du/son marcas registradas de LEGO Group. ©2023 The LEGO Group.

6467017